

BIOL(G)GLX[®]

**Manufacturer and Supplier
of Laboratory Products**

www.BiologixGroup.com

BIOL(G)GLX[®] V.11





Biologix Group Ltd

Biologix is specialized in the R & D and production of complete biobanking products, cell culture products, and general laboratory products. Taking “Serve Human Health” as the object, Biologix’s three brands: BIOLOGIX, CryoKING, and DrosoKING enjoy international excellence and reputation from the power of the sustainable innovation and continuous improvement.

Biologix focuses on the R & D and innovation of core products, and has the standard class 100,000 clean room which are compliant with GMP standards and a number of professional R & D testing laboratories which are all ISO 9001, ISO 13485, CE, and FDA registered, and follow the strict CDC guidelines for purity and efficiency. We are committed to the design and manufacture of high-quality products, enriching product lines, and strengthening the service of complete solutions.

We have developed a focus on constant innovation and improvement to offer optimal products, innovative solutions, and service to about dozens of countries and regions in Europe, America, and Asia. Biologix has been an international and well-known company in the world. We wish to strengthen the cooperation with international companies in OEM and private label services and technical cooperation hand in hand to contribute to human health.

Ordering and Services

Private Labeling

Biologix offers a Private Labeling Program, providing high quality, branded lab supplies at very competitive prices. Many Biologix products are currently private labeled and sold worldwide by some of the most prominent brands and distributors.

OEM Services

Biologix also operates as an OEM provider for plastic laboratory consumables. With through our in-house molding and tooling capabilities, we can provide the exact products needed by our customers at significantly lower costs than other companies can achieve. Biologix currently supplies some of the world's top distributors with its OEM products.

Ordering Information

A. Free Product Samples

Let us send you a FREE sample package of our great products. Contact us today if you are interested in trying out Biologix products before you buy.

B. Distribution

If interested in distribution opportunities, please contact us for distributor terms and pricing. We are accepting distribution opportunities worldwide. Please contact us at Inquiry@BiologixGroup.com.

Guaranteed Quality

Exceptional Service

Professional Design

Logical Pricing

Certifications



CE



ISO



FDA

Contents

Cell Culture Series

Cell Culture Flasks	09
Cell Culture Dishes	10
Cell Culture Plates	11
Serological Pipettes	12
Cell Culture Slides	13
Centrifuge Tubes	14
Cell Strainers	15
Sterile Syringe Filters	16
Vacuum Units	16
Cell Scrapers & Lifters	17

CryoKING Biobanking

Screw Cap Microtubes	20
Cryogenic Vials	21
Side-Coded Cryogenic Vials	22-23
Multi-Coded Cryogenic Vials	24-27
SBS Standard Cryogenic Vials	28-32
Cardboard Cryogenic Boxes	33
ID-Color™ Cardboard Cryogenic Boxes	34
PC Cryogenic Boxes	35
PP Cryogenic Boxes	36
Freezer Racks	37-38
Multi-Channel Decapper	39
Scanners	40
Tube Handling System	41
Low Temperature Freezers	42
Liquid Nitrogen Tanks	43

General Laboratory Supplies

Microcentrifuge Tubes	45
Tube Racks	46
Liquid Handling Products	
Pipette Tips	47
Filter Tips	48-49
LTS Pipette Tip	50
Refill Pack Pipette Tips	51
Automation Tips	52
Transfer Pipets	59
Solution Basins	60

Beakers	61
Reagent Bottles -Wide Mouth	62
Reagent Bottles -Narrow Mouth	63
Test Tubes	64
Slide Storage Boxes	65
Deep Well Plates	66
Sealing Films	67

PCR

PCR Tubes	68
8-Strip PCR Tubes	69
PCR Plates	70

Microbiology

Petri Dishes	71
Inoculating Loops & Needles	72
Cell Spreaders	73

Drosophila

Drosophila Vials	74
Drosophila Bottles	75
Drosophila Plugs	76
Drosophila Microscope	77

Sample Collection and

Detection Products	78
--------------------	----

Instruments

Liquid Handling	80-81
Collection System	82
Mixers & Rotators	83
Shakers	84
Thermocyclers	85
Centrifuges	86-88
Dry Bath Incubators	89-91
Electrophoresis	92
BluView Transilluminator	93
Stirrers	94-96
LCD Digital Rotary Evaporator	97
Electronic Analytical Balance	98
PH/ Conductivity Meter	99

Highlight - Top Sales



Cell Culture Flasks

Page 09



Cell Culture Plates

Page 11



Centrifuge Tubes
Page 14



Cell Strainers
Page 15



Cell
Scrapers & Lifters
Page 17



Screw Cap
Microtubes
Page 20



Multi-Coded
Cryogenic Vials
Page 24-27



Side-Coded
Cryogenic Vials
Page 22

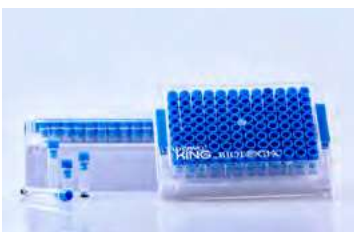

SBS Standard
Cryogenic Vials
Page 28-32



Cardboard
Cryogenic Boxes
Page 33



Low Temperature
Freezers
Page 42



Liquid Nitrogen
Tanks
Page 43

Highlight - Top Sales



Filter Tips
Page 49



LTS Pipette Tips
Page 50



Automation Tips
Page 52



Solution Basins
Page 60



Transfer Pipets
Page 59

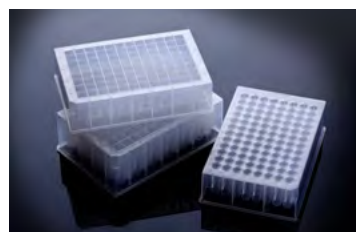

Deep Well Plates
Page 66

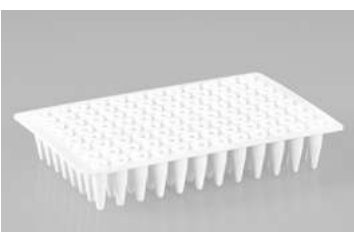

PCR Products
Page 68-70



Petri Dishes
Page 71



Liquid Handling
Page 80-81



Centrifuges
Page 86-88



Electrophoresis
Tanks
Page 92



Stirrers
Page 94-96

Catalog Number Index

Cat #	Page#	Cat #	Page#	Cat #	Page#	Cat #	Page#	Cat #	Page#
01-110X	83	01-960X	91	04-1060U	62	05-2797	82	20-0200	47
01-120X	83	01-970X	91	04-1125U	62	05-2798	82	20-1000	47
01-130X	83	01-980X	91	04-1250U	62	07-2101	13	20-1250	47
01-2101	80	01-990X	91	04-1500U	62	07-2102	13	20-1251	47
01-2102	80	01-BD203EX	98	04-1100U	62	07-2104	13	21-0010	47
01-2104	80	01-BD203NX	98	04-2008	62	07-2108	13	21-0200	47
01-2110	80	01-BD204EX	98	04-2015	62	07-3035	10	21-1000	47
01-2112	80	01-BD204NX	98	04-2030	62	07-3060	10	21-1250	47
01-2115	80	01-BD224EX	98	04-2060	62	07-3100	10	21-R0010S	51
01-2122	80	01-BD224NX	98	04-2100	62	07-3150	10	21-R0011S	51
01-2155	80	01-BD263EX	98	04-2125	62	07-5001	12	21-R0200S	51
01-220X	81	01-BD263NX	98	04-2250	62	07-5002	12	21-R0201S	51
01-221X	81	01-BE2004EX	98	04-2500	62	07-5005	12	21-R0200ES	51
01-2210	80	01-BE2004NX	98	04-3008	62	07-5010	12	21-R0201ES	51
01-2250	80	01-BE2204EX	98	04-3015	62	07-5025	12	21-R1000S	51
01-2230	80	01-BE2204NX	98	04-3030	62	07-5050	12	21-R1001S	51
01-241X	80	01-MP611	99	04-3060	62	07-6006	11	22-0010S	48
01-242X	80	01-MP613	99	04-3100	62	07-6012	11	22-0011S	48
01-243X	80	01-MP811X	99	04-3125	62	07-6024	11	22-0020S	48
01-244X	80	01-MP813X	99	04-3250	62	07-6048	11	22-0021S	48
01-270X	82	02-0008	66	04-3500	62	07-6096	11	22-0050S	48
01-2801	80	02-000C	66	04-N0004U	63	07-8025	09	22-0051S	48
01-2805	80	02-000CS	66	04-N0008U	63	07-8075	09	22-0100S	48
01-2830	80	02-0096	66	04-N0015U	63	07-8175	09	22-0101S	48
01-310X	94	02-1016	66	04-N0030U	63	07-9025	09	22-0200S	48
01-320X	94	02-1022	66	04-N0060U	63	07-9075	09	22-0201S	48
01-330X	94	02-1096	66	04-N0100U	63	07-9175	09	22-1000S	48
01-330XA	94	02-1116	66	04-N0125U	63	08-PES1322R	16	22-1001S	48
01-340X	95	02-1122	66	04-N0250U	63	08-PES2522R	16	22-1000	48
01-341X	95	02-1196	66	04-N0500U	63	08-PES3022R	16	23-0010S	49
01-343X	95	02-2010-50	66	04-N1004U	63	08-PES3322S	16	23-0011S	49
01-344X	95	02-2110	66	04-N1008U	63	08-PES3345S	16	23-0020S	49
01-350X	95	02-2196	66	04-N1015U	63	08-PES3322M	16	23-0021S	49
01-351X	95	02-2296	66	04-N1060U	63	08-PES3345M	16	23-0050S	49
01-352X	95	02-3024	66	04-N1100U	63	08-CA3022R	14	23-0051S	49
01-353X	95	02-6022	66	04-N1125U	63	08-CA3045R	16	23-0100S	49
01-361X	96	02-6122	66	04-N1250U	63	09-PES2250	16	23-0101S	49
01-362X	96	02-7022	66	04-N1500U	63	09-PES2250F	16	23-0200S	49
01-370X	96	02-7122	66	04-N2004U	63	09-CA2250	16	23-0201S	49
01-371X	96	02-8005	66	04-N2008U	63	09-CA2250F	16	23-1000S	49
01-372X	96	02-8105	66	04-N2015U	63	10-0151	14	23-1001S	49
01-373X	96	02-9010	66	04-N2030U	63	10-0152	14	23-0300S	49
01-510X	97	02-9110	66	04-N2060U	63	10-0501	14	23-0301S	49
01-520X	97	03-1300	92	04-N2100U	63	10-0502	14	23-1000	49
01-540X	97	03-2310	92	04-N2125U	63	10-0815	14	25-0051	60
01-621XA	84	03-3070	92	04-N2250U	63	10-0850	14	25-0052	60
01-631XA	84	03-3100	92	04-N2500U	63	10-9151	14	25-1025	60
01-700X	85	03-4221	90	04-N3004U	63	10-9152	14	25-1100	60
01-710X	85	03-4222	90	04-N3008U	63	10-9501	14	25-1202	60
01-800X	86	03-6210	93	04-N3015U	63	10-9502	14	30-0135	59
01-821X	86	04-0008U	62	04-N3030U	63	10-9815	14	30-0135A1	59
01-830X	87	04-0015U	62	04-N3060U	63	10-9850	14	30-0138	59
01-832X	87	04-0030U	62	04-N3100U	63	12-1275	64	30-0138A1	59
01-860X	88	04-0060U	62	04-N3125U	63	12-1299	64	30-0238A1	59
01-870X	88	04-0125U	62	04-N3250U	63	12-1300	64	41-5025	65
01-900X	91	04-0250U	62	04-N3500U	63	12-1399	64	41-5100	65
01-9A0X	91	04-0500U	62	05-2720	82	12-2275	64	41-6025	65
01-910X	89	04-0100U	62	05-2721	82	15-1040	15	41-6100	65
01-920X	89	04-1008U	62	05-2791	82	15-1070	15	51-0500	74
01-930X	90	04-1015U	62	05-2792	82	15-1100	15	51-0501	74
01-950X	91	04-1030U	62	05-2793	82	20-0010	47	51-0505	76

Catalog Number Index

Cat #	Page#	Cat #	Page#	Cat #	Page#	Cat #	Page#	Cat #	Page#
51-0510	74	61-0303	67	88-910X	25	98-4127	32	DK-31023	77
51-0511	74	61-0304	67	88-915X	25	98-4227	29	DK-31023C	77
51-0515	76	65-0001	72	88-920X	26	98-5227	29	DK-31023CK	77
51-0520	74	65-0002	72	88-921X	27	98-5327	31	DK-31023CS	77
51-0521	74	65-0010	72	88-950X	26	98-5527	31	R21-R0020S	51
51-0525	76	65-1001	73	89-423X	32	98-5627	31	R21-R0021S	51
51-0800	74	65-1010	73	89-425X	32	98-5727	31	R21-R0200S	51
51-0801	74	66-1501	71	89-428X	32	99-2212	37	R21-R0201S	51
51-0805	76	66-1515	71	89-421X	32	99-2215	37	R21-R1000S	51
51-0810	74	66-1560	71	89-508X	29	99-2216	37	R21-R1001S	51
51-0811	74	66-1701	71	89-510X-F	31	99-2220	37	R23-0020	50
51-0815	76	70-1180	17	89-510X-R	31	99-2224	37	R23-0021	50
51-0820	74	70-1250	17	89-520X-F	31	99-2225	37	R23-0200	50
51-0821	74	70-2180	17	89-520X-R	31	99-2230	37	R23-0201	50
51-0825	76	7101	65	89-550X-F	31	99-5212	38	R23-1000	50
51-17720	75	7105	65	89-550X-R	31	99-5215	38	R23-1001	50
51-17721	75	80-0015	45	89-514X	29	99-5216	38		
51-17725	76	80-0020	45	89-905X	25	99-5220	38		
51-17730	75	80-0500	45	89-910X	25	99-5224	38		
51-17731	75	80-1500	45	89-915X	25	99-5225	38		
51-17735	76	80-1500-S	45	89-920X	26	99-6206	38		
51-22720	75	80-1501	45	89-921X	27	99-6207	38		
51-22721	75	80-1503	45	89-922X	26	99-6208	38		
51-22730	75	81-0000	20	89-923X	27	99-6209	38		
51-22731	75	81-0001	20	89-950X	26	99-6210	38		
60-0008	69	81-0002	20	90-1200	33	99-6211	38		
60-0016	70	81-0003	20	90-1281	33	99-6212	38		
60-0016W	70	81-0004	20	90-1536	46	99-6213	38		
60-0056	70	81-0005	20	90-1550	46	99-7215	37		
60-0082	68	81-0006	20	90-2200	33	99-7216	37		
60-0088	69	81-0055	20	90-2281	33	99-7220	37		
60-0108	69	81-0056	20	90-2300	33	99-7224	37		
60-0156	70	81-0154	20	90-2381	33	99-7225	37		
60-0182	68	81-0204	20	90-5016	46	99-7228	37		
60-0188	69	81-0205	20	90-5025	46	CKS-1520	41		
60-0208	69	81-7055	21	90-5200	33	CKS-152X	41		
60-0256	70	81-7056	21	90-5281	33	CKS-0101	40		
60-0282	68	81-7154	21	90-8009	46	CKS-1301	40		
60-0288	69	81-7204	21	90-8100	34	CKS-4008	39		
60-0308	69	81-7205	21	90-8200	34	CKS-5008	39		
60-0356	70	81-8154	21	90-8281	34	CKS-4096	39		
60-0382	68	81-8204	21	90-8381	34	CKS-5096	39		
60-0388	69	88-4033	32	90-9009	35	AB23-0020S	52		
60-0408	69	88-4053	32	90-9025	36	AB23-0050S	52		
60-0456	70	88-4083	32	90-9081	36	AB23-0250S	52		
60-0482	68	88-4103	32	90-9100	36	AT23-0020S	52		
60-0488	69	88-508X	29	90-9200	36	AT23-0020CS	52		
60-1016	70	88-510X-F	30	90-9210	35	AT23-0050S	52		
60-1016W	70	88-510X-R	30	90-9250	35	AT23-0050CS	52		
60-1088	69	88-520X-F	30	90-9381	35	AT23-0200S	52		
60-1088W	69	88-520X-R	30	93-0050	61	AT23-0020CS	52		
61-0010	67	88-550X-F	30	93-0100	61	AT23-1000S	52		
61-0020	67	88-550X-R	30	93-0250	61	AT23-1000CS	52		
61-0040	67	88-600X	23	93-0400	61	AH23-0050S	52		
61-0041	67	88-605X	23	93-0800	61	AH23-0050CS	52		
61-0051	67	88-610X	23	93-1000	61	AH23-0300S	52		
61-0060	67	88-615X	23	98-0113	35	AH23-0300CS	52		
61-0080	67	88-620X	23	98-0200	35	AH23-1000S	52		
61-0120	67	88-621X	23	98-0213	35	AH23-1000CS	52		
61-0152	67	88-650X	23	98-0313	35	AA21-0030S	52		
61-0210	67	88-905X	25	98-1213	32	AA23-0250S	52		

"X" indicates cap color:0-White,1-Red,2-Green,3-Blue,4-Yellow,5-Purple,7-Clear

Cell Culture Series

Cell culture involves sampling cells from an organism, placing these cells in an in vitro environment, and observing the growth, reproduction, aging or other processes of the cells. Cell culture has become an important practice in life science research, and plays a central role in the development of the biotechnology industry.

The Biologix Cell Culture Series offers a range of safe and reliable basic supplies for cell transfer, filtering, and other applications.





>> Features

- Made of high quality medical grade polystyrene
- Available flask sizes include surface areas of 25 cm², 75 cm², or 175 cm²
- Plug cap and filter cap options available for all flask sizes
- Plug caps completely isolate the culture from the outside environment
- Filter caps prevent cross-contamination while meeting the requirements for gas exchange
- Short, wide, angled neck design for easy access
- Gamma radiation sterilized
- Non-pyrogenic, non-cytotoxic
- DNase & RNase free, human DNA free
- TC treated

Suitable for open culture conditions, effectively preventing cross-contamination while meeting the requirements for gas exchange in cell and tissue culture

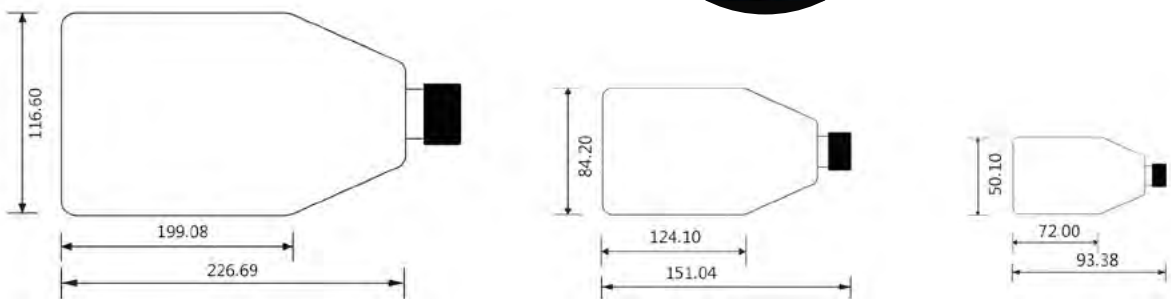

Dimensions = mm

Cat #	Cap Type	Culture Area	Working Volume	Total Volume	Surface Treatment	Sterile	Unit	Total
07-8025	Filter	25cm ²	7ml	60 ml	Yes	Yes	5 /Bag, 40 Bags/Case	200 /Case
07-8075	Filter	75cm ²	25ml	250ml	Yes	Yes	5 /Bag, 20 Bags/Case	100 /Case
07-8175	Filter	175cm ²	50ml	650ml	Yes	Yes	5 /Bag, 8 Bags/Case	40 /Case
07-9025	Plug	25cm ²	7ml	60ml	Yes	Yes	5 /Bag, 40 Bags/Case	200 /Case
07-9075	Plug	75cm ²	25ml	250ml	Yes	Yes	5 /Bag, 20 Bags/Case	100 /Case
07-9175	Plug	175cm ²	50ml	650ml	Yes	Yes	5 /Bag, 8 Bags/Case	40 /Case

Cell Culture Dishes

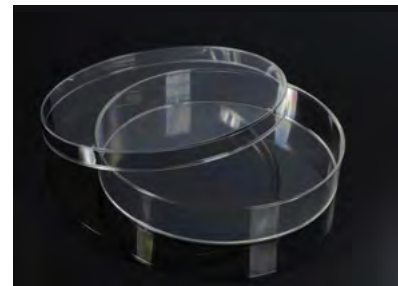
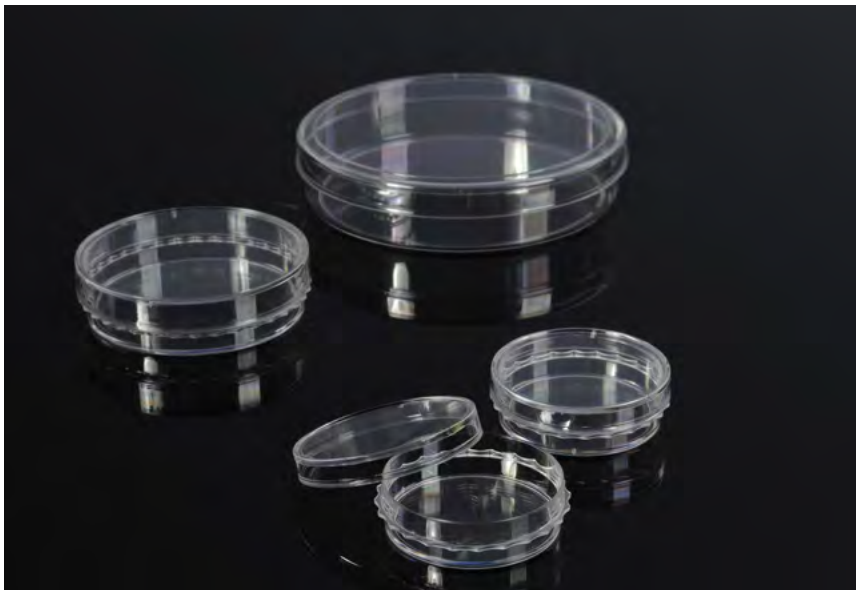

>> Features

- Made of high quality medical grade polystyrene
- Lid design promotes effective gas exchange
- External grip for easier handling (07-3035 and 07-3060)
- Raised edges for convenient stacking
- Vacuum plasma surface treatment ensures excellent cell adhesion
- Smooth, transparent materials facilitate observation of cells through a microscope
- Electron beam sterilized
- Non-pyrogenic, non-cytotoxic
- DNase & RNase free, human DNA free
- TC treated

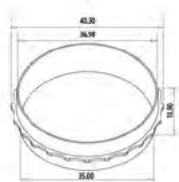

07-3035

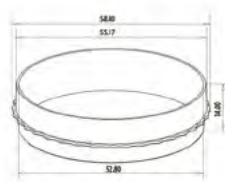

07-3060

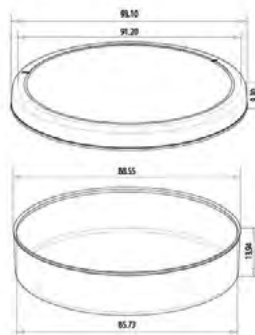

07-3100

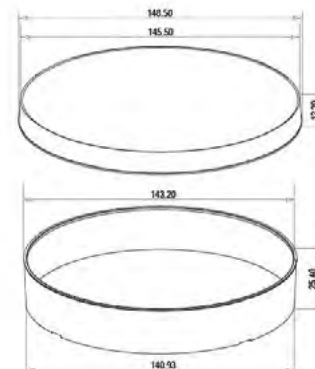

07-3150

Dimensions = mm

Cat #	Dish Style DxH(mm)	Internal Dimensions D x H (mm)	Culture Area	Working Volume	External Grip	Sterile	Unit
07-3035	35.00 x 10.00	34.30 x 9.30	9.40cm ²	3.00ml	Yes	Yes	10 /Bag, 500 /Case
07-3060	60.00 x 15.00	52.80 x 12.80	21.50cm ²	5.00ml	Yes	Yes	10 /Bag, 500 /Case
07-3100	90.00 x 20.00	86.26 x 17.70	57.50cm ²	12.50ml	No	Yes	10 /Bag, 200 /Case
07-3150	150.00 x 25.00	140.20 x 23.30	148.00cm ²	35.00ml	No	Yes	10 /Bag, 120 /Case



>> Features

- Constructed of prime virgin polystyrene
- Plate cover design minimizes the risk of cross contamination
- Thin-walled well bottoms increase thermal consistency, reducing the edge effect
- Flat well bottoms provide excellent clarity for microscopic examination of samples
- Raised well rim design around each well enables secure sealing and safeguards against evaporation
- Gamma radiation sterilized
- Non-pyrogenic, non-cytotoxic
- DNase & RNase free, human DNA free
- TC treated

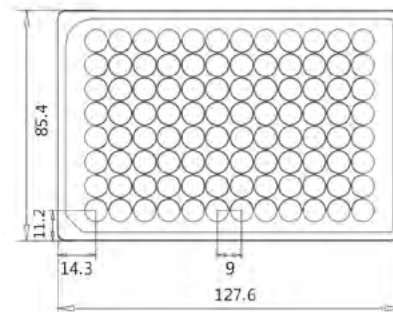
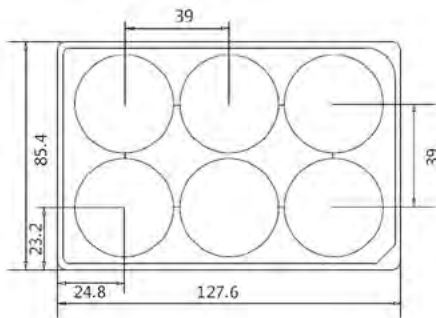

Dimensions = mm

Cat #	Wells	External Dimensions W x L x H (mm)	Well Dimensions D x H (mm)	Culture Area	Working Volume	Sterile	Unit
07-6006	6-well	85.40 x 127.60 x 20.20	35.00 x 17.50	9.6cm ²	3ml	Yes	1 /Bag, 50 Bags/Case
07-6012	12-well	85.40 x 127.60 x 20.20	21.90 x 17.50	3.8cm ²	2ml	Yes	1 /Bag, 50 Bags/Case
07-6024	24-well	85.40 x 127.60 x 20.20	15.50 x 17.50	1.9cm ²	1ml	Yes	1 /Bag, 50 Bags/Case
07-6048	48-well	85.40 x 127.60 x 20.20	9.75 x 17.50	0.75cm ²	0.5ml	Yes	1 /Bag, 50 Bags/Case
07-6096	96-well	85.40 x 127.60 x 14.40	6.50 x 10.80	0.33cm ²	0.2ml	Yes	1 /Bag, 50 Bags/Case

Serological Pipettes

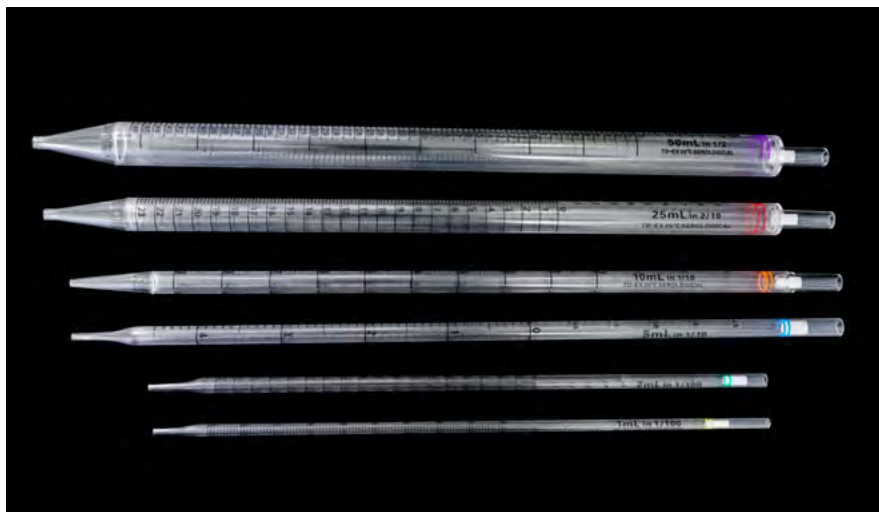

>> Features

- Constructed of highly transparent prime virgin polystyrene
- Available in 1ml, 2ml, 5ml, 10ml, 25ml, 50ml volumes
- Each volume labeled with a different color for ease of use
- Ascending and descending graduations
- Filter at the top of each pipette prevents damage to pipettors
- Electron beam sterilized
- Non-pyrogenic, non-cytotoxic
- DNase & RNase free, human DNA free

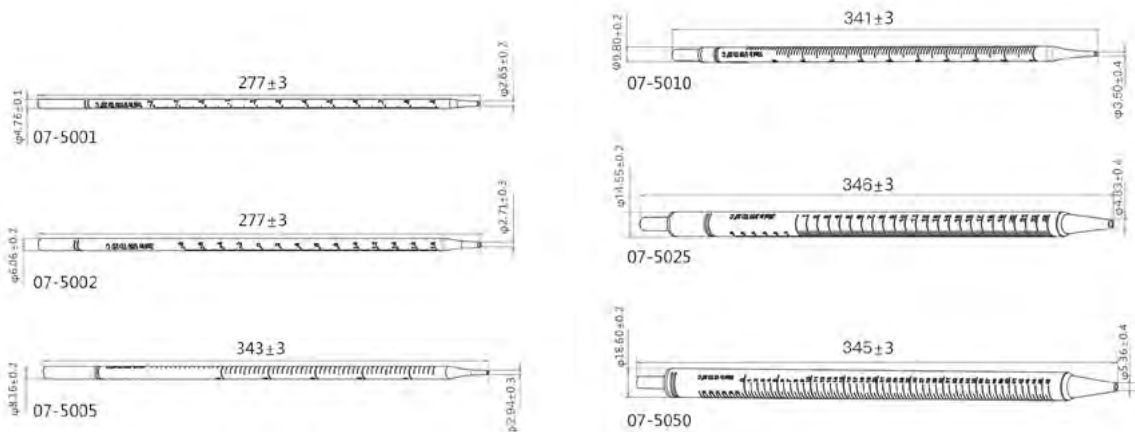

Dimensions = mm

Cat #	Working Volume	Color	Sterile	Unit	Total
07-5001	1.00ml	Yellow	Yes	1 /Bag, 200 Bags/Pack, 4 Packs/Case	800 /Case
07-5002	2.00ml	Green	Yes	1 /Bag, 150 Bags/Pack, 4 Packs/Case	600 /Case
07-5005	5.00ml	Blue	Yes	1 /Bag, 100 Bags/Pack, 4 Packs/Case	400 /Case
07-5010	10.00ml	Orange	Yes	1 /Bag, 100 Bags/Pack, 4 Packs/Case	400 /Case
07-5025	25.00ml	Red	Yes	1 /Bag, 50 Bags/Pack, 4 Packs/Case	200 /Case
07-5050	50.00ml	Purple	Yes	1 /Bag, 40 Bags/Pack, 4 Packs/Case	160 /Case

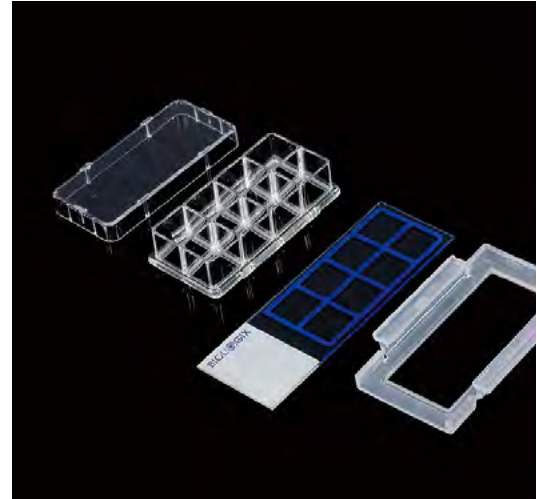

>> Features

- Easy-to-open, highly transparent slide chambers
- Chamber numbering for convenient sample identification
- Polystyrene chamber piece available with 1, 2, 4, or 8 wells
- Packing trays can be used as incubation racks in CO₂ incubators
- Slide and chamber apparatus can be easily disassembled without damaging samples
- EO Sterilized

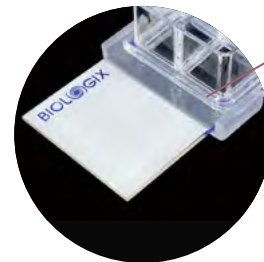
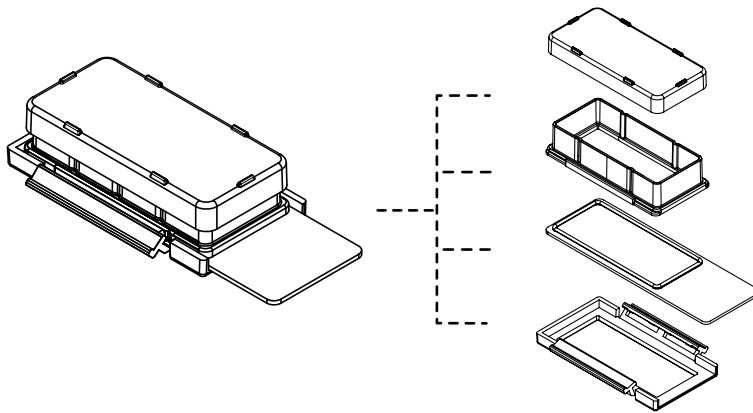

Easy-to-open,
highly transparent
slide chambers

Cat #	Material Chamber/Slide/Holder	Wells	Color	Growth Area	Working	Sterile	Unit	Total
07-2101	PS /Glass/PP	1-well	Clear	9.40cm ²	2.50-5.50ml	Yes	6 /Pack, 2 Packs/Case	12 /Case
07-2102	PS /Glass/PP	2-well	Clear	4.55cm ²	1.20-2.50ml	Yes	6 /Pack, 2 Packs/Case	12 /Case
07-2104	PS /Glass/PP	4-well	Clear	2.13cm ²	0.50-1.30ml	Yes	6 /Pack, 2 Packs/Case	12 /Case
07-2108	PS /Glass/PP	8-well	Clear	0.98cm ²	0.20-0.60ml	Yes	6 /Pack, 2 Packs/Case	12 /Case

Centrifuge Tubes



>> Features

- Tubes: made of strong, highly transparent medical grade polypropylene
- Flat-top caps: made of medical grade polyethylene
- Plug-seal screw on caps: made of medical grade polypropylene
- 15ml and 50ml conical tubes available
- Large white writing area for easy marking
- Double threaded design reduces cross-threading; caps are easily opened and closed
- Flat-top caps can be written on
- Gamma radiation sterilized, non-pyrogenic, RNase&DNase free
- Available in racked package (sterile) or bulk package (sterile & non-sterile)

Specifications

- Working temperature: stable from -20°C to 121°C (except flat-top cap)
- 15ml and 50ml tubes can withstand centrifugation of 8,400 and 9,400 G respectively
- Sealing test: complies with the International Air Transport Association (IATA) Safety Standards



Cat #	Volume	Caps	Sterile	Package	Unit	Total
10-9151	15ml	Flat Top	Yes	Rack	50 /Rack, 10 Racks /Case	500 /Case
10-9152	15ml	Flat Top	Yes	Bulk	25 /Bag, 20 Bags /Case	500 /Case
10-9501	50ml	Flat Top	Yes	Rack	25 /Rack, 20 Racks /Case	500 /Case
10-9502	50ml	Flat Top	Yes	Bulk	25 /Bag, 20 Bags /Case	500 /Case
10-9815	15ml	Flat Top	No	Bulk	500 Tubes/Bag & 500 Caps/Bag	500 /Case
10-9850	50ml	Flat Top	No	Bulk	500 Tubes/Bag & 500 Caps/Bag	500 /Case
10-0151	15ml	Plug Seal	Yes	Rack	50 /Rack, 10 Racks /Case	500 /Case
10-0152	15ml	Plug Seal	Yes	Bulk	25 /Bag, 20 Bags /Case	500 /Case
10-0501	50ml	Plug Seal	Yes	Rack	25 /Rack, 20 Racks /Case	500 /Case
10-0502	50ml	Plug Seal	Yes	Bulk	25 /Bag, 20 Bags /Case	500 /Case
10-0815	15ml	Plug Seal	No	Bulk	500 Tubes/Bag & 500 Caps/Bag	500 /Case
10-0850	50ml	Plug Seal	No	Bulk	500 Tubes/Bag & 500 Caps/Bag	500 /Case

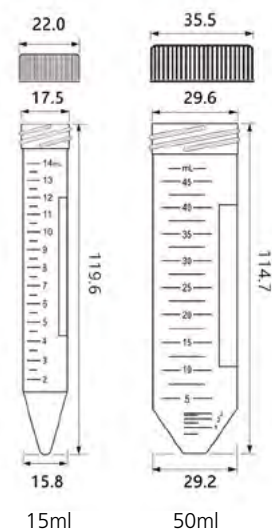

Dimensions = mm



>> Features

- Made of sturdy polypropylene and strong nylon mesh, autoclavable
- Three different pore sizes available: 40µm, 70µm, or 100µm
- Strainers are color-coded according to pore size for convenience
- Fits perfectly into Bioligix 50ml Centrifuge Tubes
- Gamma radiation sterilized, non-pyrogenic

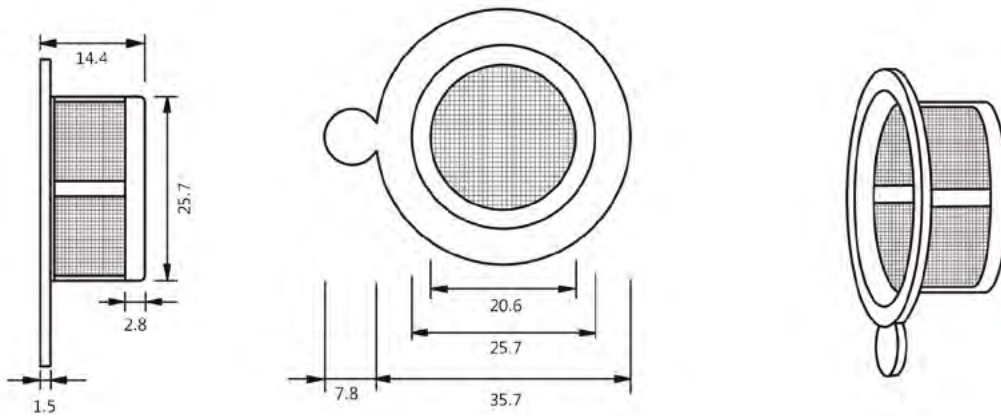

Dimensions = mm

Cat #	Size	Color	Sterile	Package	Unit	Total
15-1040	40µm	Purple	Yes	Individual	1 /Bag, 100 Bags/Case	100 /Case
15-1070	70µm	Orange	Yes	Individual	1 /Bag, 100 Bags/Case	100 /Case
15-1100	100µm	Green	Yes	Individual	1 /Bag, 100 Bags/Case	100 /Case

Sterile Syringe Filters & Vacuum Units



>> Features

- Syringe filters are suitable for 1ml~150ml liquid or solution, vacuum units are suitable for 150ml~2L liquid or solution
- Single use and gamma ray pre-sterilized
- Sterile graded 0.2um membrane: LRV > 7 for *Brevundimonas diminuta*, ATCC19146
- Non-pyrogenic, low extractables and surfactant-free ensures purity of filtrate
- Extreme-low protein binding <1.5% (PES)
- Excellent throughput, for faster filtration and more process volume
- The types of membranes are available in PES, CA, NY, PTFE, PVDF

Cat #	Description	Sterile	Unit
08-PES1322R	Syringe filters. Membrane: PES, pore size: 0.22µm, diameter:13mm. Female luer lock + male luer slip. Extreme-low protein binding. Individually packed	Yes	100 /Pack, 8 Packs/Case
08-PES2522R	Syringe filters. Membrane: PES, pore size: 0.22µm, diameter:25mm. Female luer lock + male luer slip. Extreme-low protein binding. Individually packed	Yes	100 /Pack, 4 Packs/Case
08-PES3022R	Syringe filters. Membrane: PES, pore size: 0.22µm, diameter:30mm. Female luer lock + male luer slip. Extreme-low protein binding. Individually packed	Yes	100 /Pack, 4 Packs/Case
08-PES3322S	Syringe filters. Membrane: PES, pore size: 0.22µm, diameter:33mm. Double luer lock. Extreme-low protein binding. Individually packed	Yes	100 /Pack, 4 Packs/Case
08-PES3345S	Syringe filters. Membrane: PES, pore size: 0.45µm, diameter:33mm. Double luer lock. Extreme-low protein binding. Individually packed	Yes	100 /Pack, 4 Packs/Case
08-PES3322M	Syringe filters. Membrane: PES, pore size: 0.22µm, diameter:33mm. Female luer lock + male luer slip. High pressure resistance. Individually packed	Yes	100 /Pack, 4 Packs/Case
08-PES3345M	Syringe filters. Membrane: PES, pore size: 0.45µm, diameter:33mm. Female luer lock + male luer slip. High pressure resistance. Individually packed	Yes	100 /Pack, 4 Packs/Case
08-CA3022R	Syringe filters. Membrane: CA, pore size: 0.22µm, diameter:30mm. Female luer lock + male luer slip. High biocompatibility. Individually packed	Yes	100 /Pack, 4 Packs/Case
08-CA3045R	Syringe filters. Membrane: CA, pore size: 0.45µm, diameter:30mm. Female luer lock + male luer slip. High biocompatibility. Individually packed	Yes	100 /Pack, 4 Packs/Case
09-PES2250	Vacuum filtration unit. Membrane: PES, pore size: 0.22µm, diameter:90mm, funnel volume: 500ml, receiver volume: 500ml	Yes	12 /Case
09-PES2250F	Vacuum filtration unit-funnel. Membrane: PES, pore size: 0.22µm, diameter:90mm, funnel volume: 500ml	Yes	24 /Case
09-CA2250	Vacuum filtration unit. Membrane: CA, pore size: 0.22µm, diameter:90mm, funnel volume: 500ml, receiver volume: 500ml	Yes	12 /Case
09-CA2250F	Vacuum filtration unit-funnel. Membrane: CA, pore size: 0.22µm, diameter:90mm, funnel volume: 500ml	Yes	24 /Case

*For more models, please contact the sales manager.



>> Features

Cell Scrapers

- Made of polyethylene
- Available in two sizes: 18cm or 25cm in length
- Pivoting blade makes precise cutting and scraping movements
- Gamma radiation sterilized, non-pyrogenic

Cell Lifters

- Made of polyethylene
- One-piece design and chiseled blade provide improved control while minimizing damage to cells
- Gamma radiation sterilized, non-pyrogenic

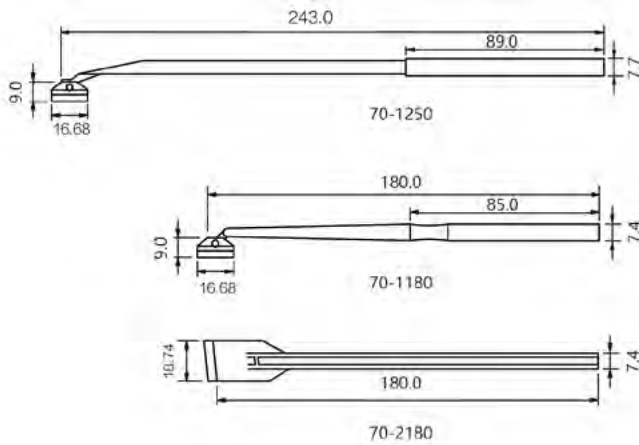

Dimensions = mm

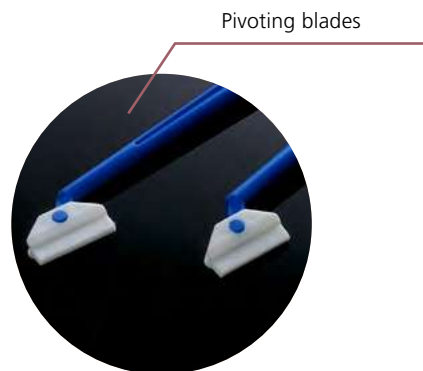

Cat #	Product	Handle Length	Sterile	Package	Unit	Total
70-2180	Cell Lifter	18cm	Yes	Individual	1 /Bag, 100 Bags/Case	100 /Case
70-1180	Cell Scraper	18cm	Yes	Individual	1 /Bag, 100 Bags/Case	100 /Case
70-1250	Cell Scraper	24.3cm	Yes	Individual	1 /Bag, 200 Bags/Case	200 /Case

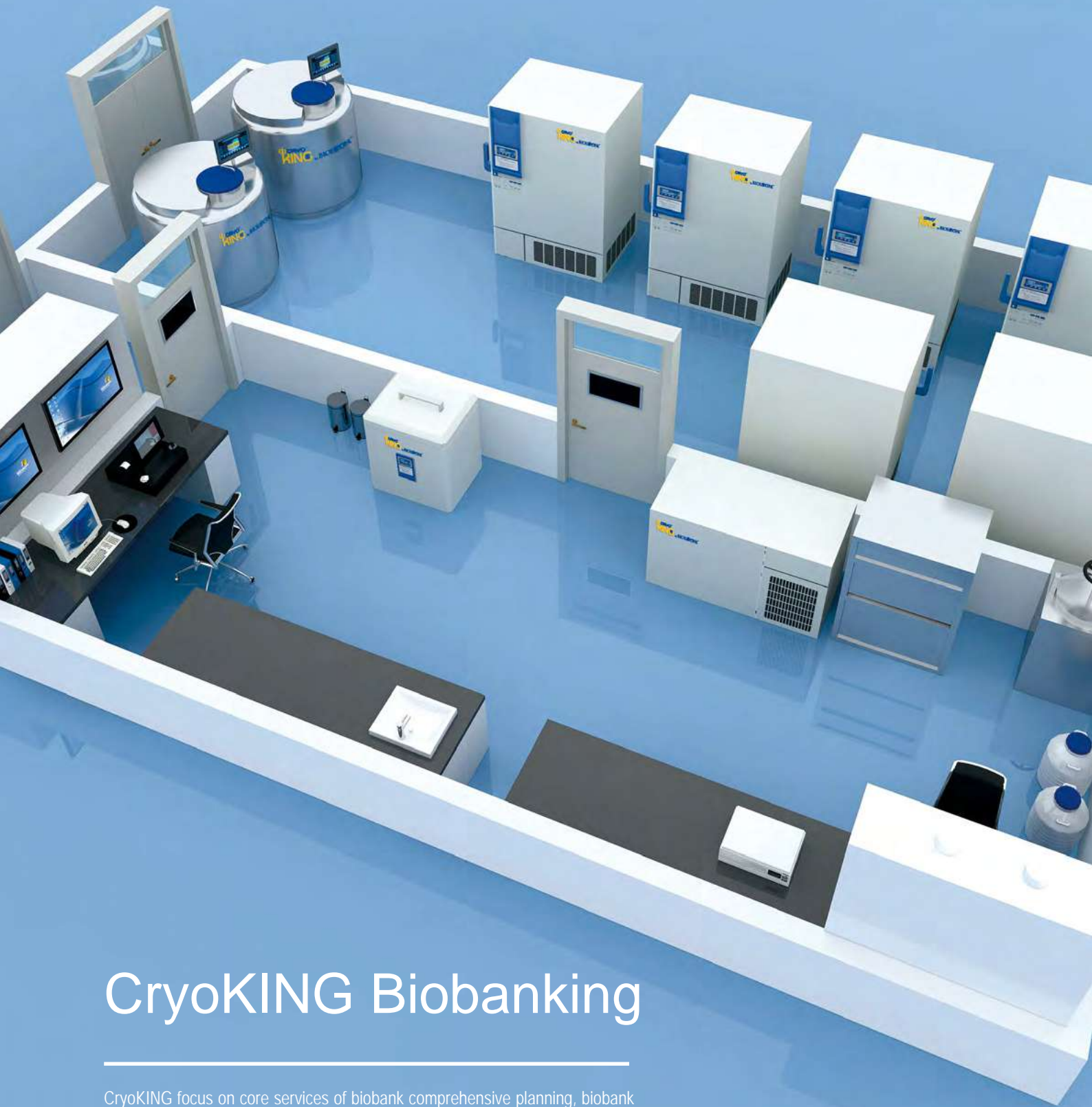

CryoKING Biobanking

CryoKING focus on core services of biobank comprehensive planning, biobank product supply and biobank systematic training, which continuously enhance systematic service ability. We are building a one-stop supply model featuring high automation degree, advanced modular function, perfect information layout, and full provision of hardware and software.

CRYOKING MULTI-CODED CRYOGENIC VIALS ENHANCE BIOBANKING MANAGEMENT

CryoKING multiple codes include side 1D barcode, side human-readable code, laser etched bottom 2D code, and bottom human-readable code. These codes can be read by various scanners and efficiently lower the risks of information loss. Multi-coded cryogenic vials enable the storage security and enhance biobanking management.



ONE-INCH REVOLUTION

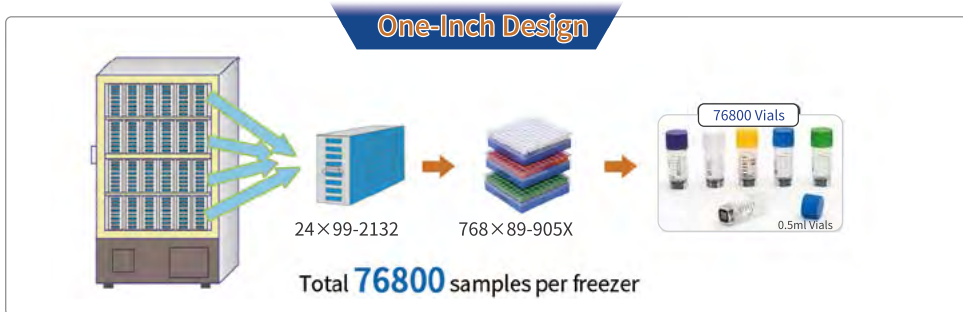

CryoKING One-Inch Revolution doubles your sample storage with half of the space and cost. 34032 extra samples can be stored per freezer.

In the same storage space, 100-welled cryogenic boxes (10×10) can store 23% more samples compared with 81-welled cryogenic boxes (9×9).

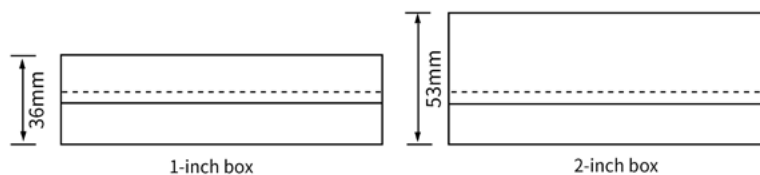

Screw Cap Microtubes



>> Features

- Made of medical grade polypropylene
- Can be repeatedly frozen and thawed
- Universal screw threads for use
- Tubes fit most common rotors and standard 1-inch and 2-inch boxes
- DNase & RNase free, endotoxin free, and human DNA free
- Autoclavable to 121°C and freezable to -86°C

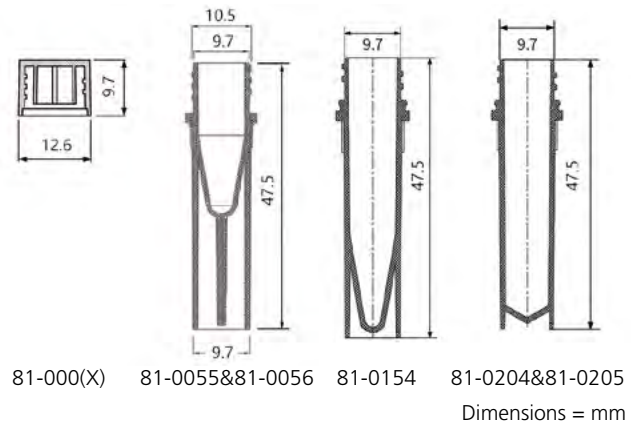

81-0055



81-0056



81-0154



81-0204



81-0205



Caps

Cat#	Type	Volume	Height (mm)	Color	Bottom	Sterile	Unit	Total
81-0055	Tubes	0.5ml	47.2	Brown	Self-Standing	No	500 /Bag/Pack, 10 Packs/Case	5000 /Case
81-0056	Tubes	0.5ml	47.2	Clear	Self-Standing	No	500 /Bag/Pack, 10 Packs/Case	5000 /Case
81-0154	Tubes	1.5ml	47.2	Clear	Self-Standing	No	500 /Bag/Pack, 10 Packs/Case	5000 /Case
81-0204	Tubes	2.0ml	47.2	Clear	Self-Standing	No	500 /Bag/Pack, 10 Packs/Case	5000 /Case
81-0205	Tubes	2.0ml	47.2	Brown	Self-Standing	No	500 /Bag/Pack, 10 Packs/Case	5000 /Case
81-0000	Caps	-	9.7	Clear	-	No	500 /Bag/Pack, 10 Packs/Case	5000 /Case
81-0001*	Caps	-	9.7	Pink	-	No	500 /Bag/Pack, 10 Packs/Case	5000 /Case
81-0002*	Caps	-	9.7	Green	-	No	500 /Bag/Pack, 10 Packs/Case	5000 /Case
81-0003*	Caps	-	9.7	Blue	-	No	500 /Bag/Pack, 10 Packs/Case	5000 /Case
81-0004*	Caps	-	9.7	Yellow	-	No	500 /Bag/Pack, 10 Packs/Case	5000 /Case
81-0005*	Caps	-	9.7	Assorted	-	No	500 /Bag/Pack, 10 Packs/Case	5000 /Case
81-0006	Caps	-	9.7	Brown	-	No	500 /Bag/Pack, 10 Packs/Case	5000 /Case

* Call for details.



>> Features

- Made of medical grade polypropylene; Autoclavable
- Can be repeatedly frozen and thawed
- Universal screw threads for use; Self-standing bottom
- Tubes fit most common rotors and standard 2-inch boxes
- Gamma radiation sterilized
- DNase & RNase free, endotoxin free, and human DNA free
- 81-8204 has a writing area and black graduation mark
- 81-8154 has black graduation mark
- Autoclavable to 121 C and freezable to -86 C
- OEM service is available

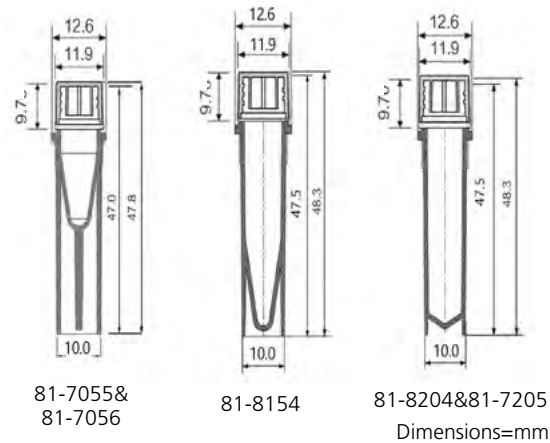

81-7055



81-7056



81-8154



81-7205



81-8204

Cat #	Volume	Color	Height (mm)	Bottom	Writing Area	Sterile	Unit	Total
81-7055	0.5ml	Brown	47.5	Self-Standing	No	Yes	50 /Bag, 10 Bags/Pack, 4 Packs/Case	2000 /Case
81-7056	0.5ml	Clear	47.5	Self-Standing	No	Yes	50 /Bag, 10 Bags/Pack, 4 Packs/Case	2000 /Case
81-8154	1.5ml	Clear	47.5	Self-Standing	Yes	Yes	50 /Bag, 10 Bags/Pack, 4 Packs/Case	2000 /Case
81-7205	2.0ml	Brown	47.5	Self-Standing	No	Yes	50 /Bag, 10 Bags/Pack, 4 Packs/Case	2000 /Case
81-8204	2.0ml	Clear	47.5	Self-Standing	Yes	Yes	50 /Bag, 10 Bags/Pack, 4 Packs/Case	2000 /Case
81-7154*	1.5ml	Clear	47.5	Self-Standing	No	Yes	50 /Bag, 10 Bags/Pack, 4 Packs/Case	2000 /Case
81-7204*	2.0ml	Clear	47.5	Self-Standing	No	Yes	50 /Bag, 10 Bags/Pack, 4 Packs/Case	2000 /Case

* No printing: 81-7154, 81-7204-MOQ required.

Side-Coded Cryogenic Vials



>> Features

- Made of medical grade polypropylene; Autoclavable; and can be repeatedly frozen and thawed
- Volumes: 0.5ml, 1.0ml, 1.5ml, 2.0ml and 5.0ml
Colors: Vials with caps which are available in 7 colors
Bottom: Self-standing
- 2ml vials are available with both external and internal screw threads. External thread screw vials' caps have no O-ring, which reduces the contamination
- Fit standard 1in, 2in, and 3.75in cryogenic boxes
- Tubes with black graduation mark and white writing area
- Gamma radiations sterilized, RNase and DNase free, endotoxin free and foreign DNA free. Non-pyrogenic
- Pre-set 1D barcode and numbers on sides for immediate scanning

Specifications

- Working temperature: stable from -196°C to 121°C
- Suitable for liquid nitrogen freezing(vapor phase)

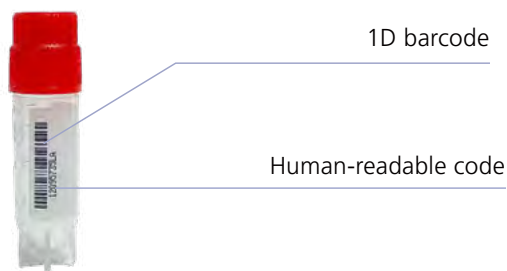

Inserts fit 2.0ml and 5.0ml vials' caps

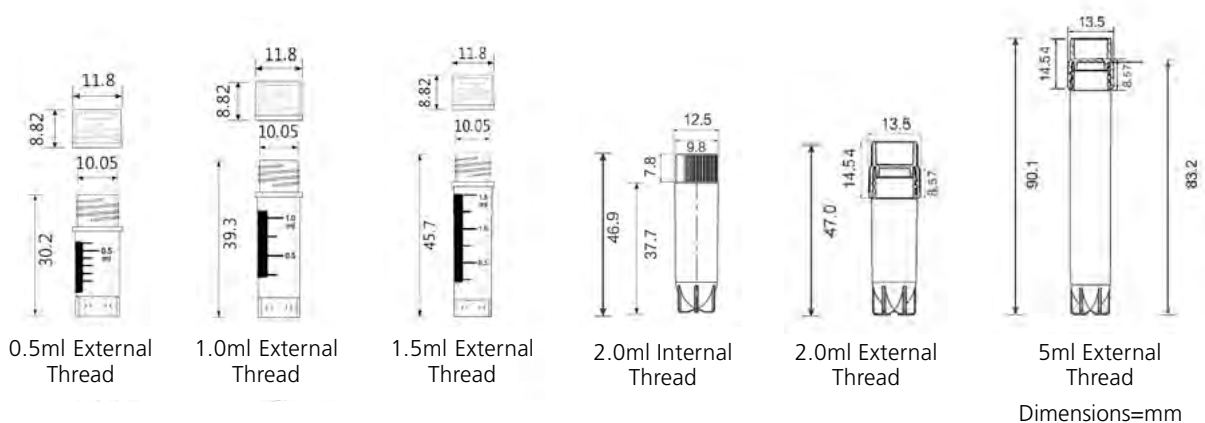

Side-Coded Cryogenic Vials

Bottom



0.5ml External Thread



1.0ml External Thread



1.5ml External Thread



2.0ml External Thread

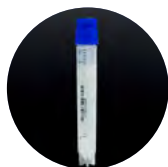

5.0ml External Thread



2.0ml Internal Thread



*Inserts fit 2.0ml and 5.0ml vial caps

Cat#	Volume	Thread Type	Color	Unit	Total
88-6050	0.5ml	External	White	25 Sets/ Bag, 20 Bags/Pack, 2 Packs/Case	1000 Sets/Case
88-6051	0.5ml	External	Red	25 Sets/ Bag, 20 Bags/Pack, 2 Packs/Case	1000 Sets/Case
88-6052	0.5ml	External	Green	25 Sets/ Bag, 20 Bags/Pack, 2 Packs/Case	1000 Sets/Case
88-6053	0.5ml	External	Blue	25 Sets/ Bag, 20 Bags/Pack, 2 Packs/Case	1000 Sets/Case
88-6054	0.5ml	External	Yellow	25 Sets/ Bag, 20 Bags/Pack, 2 Packs/Case	1000 Sets/Case
88-6055	0.5ml	External	Purple	25 Sets/ Bag, 20 Bags/Pack, 2 Packs/Case	1000 Sets/Case
88-6057	0.5ml	External	Clear	25 Sets/ Bag, 20 Bags/Pack, 2 Packs/Case	1000 Sets/Case
88-6100	1.0ml	External	White	25 Sets/ Bag, 20 Bags/Pack, 2 Packs/Case	1000 Sets/Case
88-6101	1.0ml	External	Red	25 Sets/ Bag, 20 Bags/Pack, 2 Packs/Case	1000 Sets/Case
88-6102	1.0ml	External	Green	25 Sets/ Bag, 20 Bags/Pack, 2 Packs/Case	1000 Sets/Case
88-6103	1.0ml	External	Blue	25 Sets/ Bag, 20 Bags/Pack, 2 Packs/Case	1000 Sets/Case
88-6104	1.0ml	External	Yellow	25 Sets/ Bag, 20 Bags/Pack, 2 Packs/Case	1000 Sets/Case
88-6105	1.0ml	External	Purple	25 Sets/ Bag, 20 Bags/Pack, 2 Packs/Case	1000 Sets/Case
88-6107	1.0ml	External	Clear	25 Sets/ Bag, 20 Bags/Pack, 2 Packs/Case	1000 Sets/Case
88-6150	1.5ml	External	White	25 Sets/ Bag, 20 Bags/Pack, 2 Packs/Case	1000 Sets/Case
88-6151	1.5ml	External	Red	25 Sets/ Bag, 20 Bags/Pack, 2 Packs/Case	1000 Sets/Case
88-6152	1.5ml	External	Green	25 Sets/ Bag, 20 Bags/Pack, 2 Packs/Case	1000 Sets/Case
88-6153	1.5ml	External	Blue	25 Sets/ Bag, 20 Bags/Pack, 2 Packs/Case	1000 Sets/Case
88-6154	1.5ml	External	Yellow	25 Sets/ Bag, 20 Bags/Pack, 2 Packs/Case	1000 Sets/Case
88-6155	1.5ml	External	Purple	25 Sets/ Bag, 20 Bags/Pack, 2 Packs/Case	1000 Sets/Case
88-6157	1.5ml	External	Clear	25 Sets/ Bag, 20 Bags/Pack, 2 Packs/Case	1000 Sets/Case

* Bottom

Cat#	Volume	Thread Type	Color	Unit	Total
88-6200	2.0ml	External	White	25 Sets/ Bag, 20 Bags/Pack, 2 Packs/Case	1000 Sets/Case
88-6201	2.0ml	External	Red	25 Sets/ Bag, 20 Bags/Pack, 2 Packs/Case	1000 Sets/Case
88-6202	2.0ml	External	Green	25 Sets/ Bag, 20 Bags/Pack, 2 Packs/Case	1000 Sets/Case
88-6203	2.0ml	External	Blue	25 Sets/ Bag, 20 Bags/Pack, 2 Packs/Case	1000 Sets/Case
88-6204	2.0ml	External	Yellow	25 Sets/ Bag, 20 Bags/Pack, 2 Packs/Case	1000 Sets/Case
88-6205	2.0ml	External	Purple	25 Sets/ Bag, 20 Bags/Pack, 2 Packs/Case	1000 Sets/Case
88-6207	2.0ml	External	Clear	25 Sets/ Bag, 20 Bags/Pack, 2 Packs/Case	1000 Sets/Case
88-6500	5.0ml	External	White	25 Sets/ Bag, 20 Bags/Pack, 2 Packs/Case	1000 Sets/Case
88-6501	5.0ml	External	Red	25 Sets/ Bag, 20 Bags/Pack, 2 Packs/Case	1000 Sets/Case
88-6502	5.0ml	External	Green	25 Sets/ Bag, 20 Bags/Pack, 2 Packs/Case	1000 Sets/Case
88-6503	5.0ml	External	Blue	25 Sets/ Bag, 20 Bags/Pack, 2 Packs/Case	1000 Sets/Case
88-6504	5.0ml	External	Yellow	25 Sets/ Bag, 20 Bags/Pack, 2 Packs/Case	1000 Sets/Case
88-6505	5.0ml	External	Purple	25 Sets/ Bag, 20 Bags/Pack, 2 Packs/Case	1000 Sets/Case
88-6507	5.0ml	External	Clear	25 Sets/ Bag, 20 Bags/Pack, 2 Packs/Case	1000 Sets/Case

Cat#	Volume	Thread Type	Color	Unit	Total
88-6210	2.0ml	Internal, O-ring	White	25 Sets/ Bag, 20 Bags/Pack, 2 Packs/Case	1000 Sets/Case
88-6211	2.0ml	Internal, O-ring	Red	25 Sets/ Bag, 20 Bags/Pack, 2 Packs/Case	1000 Sets/Case
88-6212	2.0ml	Internal, O-ring	Green	25 Sets/ Bag, 20 Bags/Pack, 2 Packs/Case	1000 Sets/Case
88-6213	2.0ml	Internal, O-ring	Blue	25 Sets/ Bag, 20 Bags/Pack, 2 Packs/Case	1000 Sets/Case
88-6214	2.0ml	Internal, O-ring	Yellow	25 Sets/ Bag, 20 Bags/Pack, 2 Packs/Case	1000 Sets/Case
88-6215	2.0ml	Internal, O-ring	Purple	25 Sets/ Bag, 20 Bags/Pack, 2 Packs/Case	1000 Sets/Case
88-6217	2.0ml	Internal, O-ring	Clear	25 Sets/ Bag, 20 Bags/Pack, 2 Packs/Case	1000 Sets/Case

Cat#	Color	Unit	Total
88-6000	White	100 /Bag, 30 Bags/ Case	3000 /Case
88-6001	Red	100 /Bag, 30 Bags/ Case	3000 /Case
88-6002	Green	100 /Bag, 30 Bags/ Case	3000 /Case
88-6003	Blue	100 /Bag, 30 Bags/ Case	3000 /Case
88-6004	Yellow	100 /Bag, 30 Bags/ Case	3000 /Case
88-6005	Purple	100 /Bag, 30 Bags/ Case	3000 /Case
88-6006	Assorted colors	100 /Bag, 30 Bags/ Case	3000 /Case

Multi-Coded Cryogenic Vials



>> Features

- Made of medical grade polypropylene; Autoclavable; and can be repeatedly frozen and thawed
- Volumes: 0.5ml, 1.0ml, 1.5ml, 2.0ml and 5.0ml
Colors: Vials with caps which are available in 7 colors
Bottom: Self-standing
- 2ml vials are available with both external and internal screw threads. External thread vials' caps have no O-ring, which reduces the possibility of contamination
- Fit standard 1in, 2in and 3.75in cryogenic boxes
- Tubes with black graduation mark and white writing area
- Gamma radiations sterilized, RNase and DNase free, endotoxin free and foreign DNA free, non-pyrogenic
- Pre-set 1D barcode and Human-readable code on the side for visual identification, and can be read by various scanners
- Bulk vials and racked vials all available
- Vials with pre-set Datamatrix 2D barcode are available, and the 2D barcode can be customized

Specifications

- Working temperature: stable from -196°C to 121°C
- Suitable for liquid nitrogen freezing(vapor phase)

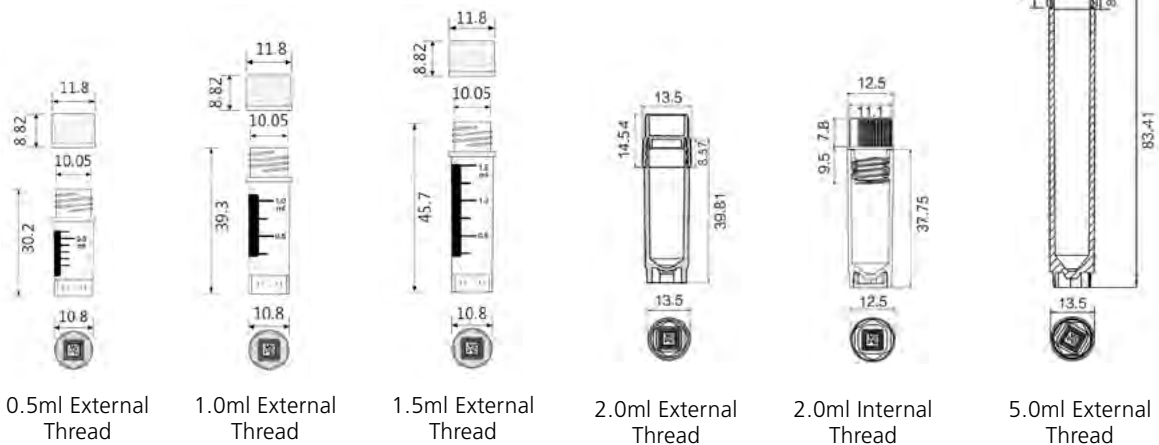

Dimensions = mm

Multi-Coded Cryogenic Vials

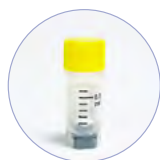

0.5ml External Thread, Bulk Vials



1.0ml External Thread, Bulk Vials

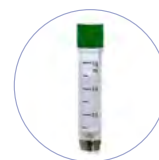

1.5ml External Thread, Bulk Vials

Cat#	Volume	Thread Type	Color	Unit	Total
88-9050	0.5ml	External	White	25 Sets/ Bag, 20 Bags/Pack, 2 Packs/Case	1000 Sets/Case
88-9051	0.5ml	External	Red	25 Sets/ Bag, 20 Bags/Pack, 2 Packs/Case	1000 Sets/Case
88-9052	0.5ml	External	Green	25 Sets/ Bag, 20 Bags/Pack, 2 Packs/Case	1000 Sets/Case
88-9053	0.5ml	External	Blue	25 Sets/ Bag, 20 Bags/Pack, 2 Packs/Case	1000 Sets/Case
88-9054	0.5ml	External	Yellow	25 Sets/ Bag, 20 Bags/Pack, 2 Packs/Case	1000 Sets/Case
88-9055	0.5ml	External	Purple	25 Sets/ Bag, 20 Bags/Pack, 2 Packs/Case	1000 Sets/Case
88-9057	0.5ml	External	Clear	25 Sets/ Bag, 20 Bags/Pack, 2 Packs/Case	1000 Sets/Case
88-9100	1.0ml	External	White	25 Sets/ Bag, 20 Bags/Pack, 2 Packs/Case	1000 Sets/Case
88-9101	1.0ml	External	Red	25 Sets/ Bag, 20 Bags/Pack, 2 Packs/Case	1000 Sets/Case
88-9102	1.0ml	External	Green	25 Sets/ Bag, 20 Bags/Pack, 2 Packs/Case	1000 Sets/Case
88-9103	1.0ml	External	Blue	25 Sets/ Bag, 20 Bags/Pack, 2 Packs/Case	1000 Sets/Case
88-9104	1.0ml	External	Yellow	25 Sets/ Bag, 20 Bags/Pack, 2 Packs/Case	1000 Sets/Case
88-9105	1.0ml	External	Purple	25 Sets/ Bag, 20 Bags/Pack, 2 Packs/Case	1000 Sets/Case
88-9107	1.0ml	External	Clear	25 Sets/ Bag, 20 Bags/Pack, 2 Packs/Case	1000 Sets/Case
88-9150	1.5ml	External	White	25 Sets/ Bag, 20 Bags/Pack, 2 Packs/Case	1000 Sets/Case
88-9151	1.5ml	External	Red	25 Sets/ Bag, 20 Bags/Pack, 2 Packs/Case	1000 Sets/Case
88-9152	1.5ml	External	Green	25 Sets/ Bag, 20 Bags/Pack, 2 Packs/Case	1000 Sets/Case
88-9153	1.5ml	External	Blue	25 Sets/ Bag, 20 Bags/Pack, 2 Packs/Case	1000 Sets/Case
88-9154	1.5ml	External	Yellow	25 Sets/ Bag, 20 Bags/Pack, 2 Packs/Case	1000 Sets/Case
88-9155	1.5ml	External	Purple	25 Sets/ Bag, 20 Bags/Pack, 2 Packs/Case	1000 Sets/Case
88-9157	1.5ml	External	Clear	25 Sets/ Bag, 20 Bags/Pack, 2 Packs/Case	1000 Sets/Case



0.5ml External Thread, Racked Vials



1.0ml External Thread, Racked Vials

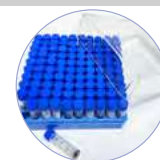

1.5ml External Thread, Racked Vials

Cat#	Volume	Thread Type	Color	Wells	Dimensions(mm)	Unit	Total
89-9050	0.5ml Vials + 1 in Box	External	White	100 Wells	133X133X36	6 Bags/Pack, 2 Packs/Case	1200 Vials/Case
89-9051	0.5ml Vials + 1 in Box	External	Red	100 Wells	133X133X36	6 Bags/Pack, 2 Packs/Case	1200 Vials/Case
89-9052	0.5ml Vials + 1 in Box	External	Green	100 Wells	133X133X36	6 Bags/Pack, 2 Packs/Case	1200 Vials/Case
89-9053	0.5ml Vials + 1 in Box	External	Blue	100 Wells	133X133X36	6 Bags/Pack, 2 Packs/Case	1200 Vials/Case
89-9054	0.5ml Vials + 1 in Box	External	Yellow	100 Wells	133X133X36	6 Bags/Pack, 2 Packs/Case	1200 Vials/Case
89-9055	0.5ml Vials + 1 in Box	External	Purple	100 Wells	133X133X36	6 Bags/Pack, 2 Packs/Case	1200 Vials/Case
89-9057	0.5ml Vials + 1 in Box	External	Clear	100 Wells	133X133X36	6 Bags/Pack, 2 Packs/Case	1200 Vials/Case
89-9100	1.0ml Vials + 2 in Box	External	White	100 Wells	133X133X53	6 Bags/Pack, 2 Packs/Case	1200 Vials/Case
89-9101	1.0ml Vials + 2 in Box	External	Red	100 Wells	133X133X53	6 Bags/Pack, 2 Packs/Case	1200 Vials/Case
89-9102	1.0ml Vials + 2 in Box	External	Green	100 Wells	133X133X53	6 Bags/Pack, 2 Packs/Case	1200 Vials/Case
89-9103	1.0ml Vials + 2 in Box	External	Blue	100 Wells	133X133X53	6 Bags/Pack, 2 Packs/Case	1200 Vials/Case
89-9104	1.0ml Vials + 2 in Box	External	Yellow	100 Wells	133X133X53	6 Bags/Pack, 2 Packs/Case	1200 Vials/Case
89-9105	1.0ml Vials + 2 in Box	External	Purple	100 Wells	133X133X53	6 Bags/Pack, 2 Packs/Case	1200 Vials/Case
89-9107	1.0ml Vials + 2 in Box	External	Clear	100 Wells	133X133X53	6 Bags/Pack, 2 Packs/Case	1200 Vials/Case
89-9150	1.5ml Vials + 2 in Box	External	White	100 Wells	133X133X53	6 Bags/Pack, 2 Packs/Case	1200 Vials/Case
89-9151	1.5ml Vials + 2 in Box	External	Red	100 Wells	133X133X53	6 Bags/Pack, 2 Packs/Case	1200 Vials/Case
89-9152	1.5ml Vials + 2 in Box	External	Green	100 Wells	133X133X53	6 Bags/Pack, 2 Packs/Case	1200 Vials/Case
89-9153	1.5ml Vials + 2 in Box	External	Blue	100 Wells	133X133X53	6 Bags/Pack, 2 Packs/Case	1200 Vials/Case
89-9154	1.5ml Vials + 2 in Box	External	Yellow	100 Wells	133X133X53	6 Bags/Pack, 2 Packs/Case	1200 Vials/Case
89-9155	1.5ml Vials + 2 in Box	External	Purple	100 Wells	133X133X53	6 Bags/Pack, 2 Packs/Case	1200 Vials/Case
89-9157	1.5ml Vials + 2 in Box	External	Clear	100 Wells	133X133X53	6 Bags/Pack, 2 Packs/Case	1200 Vials/Case

Multi-Coded Cryogenic Vials



2.0ml External Thread,
Bulk Vials



5.0ml External Thread,
Bulk Vials

Cat#	Volume	Thread Type	Color	Unit	Total
88-9200	2.0ml	External	White	25 Sets/Bag, 20 Bags/Pack, 2 Packs/Case	1000 Sets/Case
88-9201	2.0ml	External	Red	25 Sets/Bag, 20 Bags/Pack, 2 Packs/Case	1000 Sets/Case
88-9202	2.0ml	External	Green	25 Sets/Bag, 20 Bags/Pack, 2 Packs/Case	1000 Sets/Case
88-9203	2.0ml	External	Blue	25 Sets/Bag, 20 Bags/Pack, 2 Packs/Case	1000 Sets/Case
88-9204	2.0ml	External	Yellow	25 Sets/Bag, 20 Bags/Pack, 2 Packs/Case	1000 Sets/Case
88-9205	2.0ml	External	Purple	25 Sets/Bag, 20 Bags/Pack, 2 Packs/Case	1000 Sets/Case
88-9207	2.0ml	External	Clear	25 Sets/Bag, 20 Bags/Pack, 2 Packs/Case	1000 Sets/Case
88-9500	5.0ml	External	White	25 Sets/Bag, 20 Bags/Pack, 2 Packs/Case	1000 Sets/Case
88-9501	5.0ml	External	Red	25 Sets/Bag, 20 Bags/Pack, 2 Packs/Case	1000 Sets/Case
88-9502	5.0ml	External	Green	25 Sets/Bag, 20 Bags/Pack, 2 Packs/Case	1000 Sets/Case
88-9503	5.0ml	External	Blue	25 Sets/Bag, 20 Bags/Pack, 2 Packs/Case	1000 Sets/Case
88-9504	5.0ml	External	Yellow	25 Sets/Bag, 20 Bags/Pack, 2 Packs/Case	1000 Sets/Case
88-9505	5.0ml	External	Purple	25 Sets/Bag, 20 Bags/Pack, 2 Packs/Case	1000 Sets/Case
88-9507	5.0ml	External	Clear	25 Sets/Bag, 20 Bags/Pack, 2 Packs/Case	1000 Sets/Case

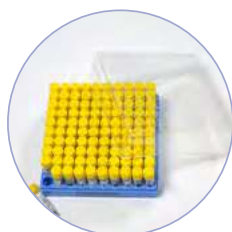

2.0ml External Thread,
Racked Vials

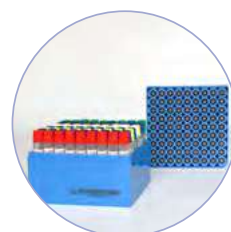

5.0ml External Thread,
Racked Vials

Cat#	Volume	Thread Type	Color	Wells	Dimensions(mm)	Unit	Total
89-9200	2.0ml Vials + 2 in Box	External	White	81 Wells	133X133X53	6 Bags/Pack, 2 Packs/Case	972 Vials/Case
89-9201	2.0ml Vials + 2 in Box	External	Red	81 Wells	133X133X53	6 Bags/Pack, 2 Packs/Case	972 Vials/Case
89-9202	2.0ml Vials + 2 in Box	External	Green	81 Wells	133X133X53	6 Bags/Pack, 2 Packs/Case	972 Vials/Case
89-9203	2.0ml Vials + 2 in Box	External	Blue	81 Wells	133X133X53	6 Bags/Pack, 2 Packs/Case	972 Vials/Case
89-9204	2.0ml Vials + 2 in Box	External	Yellow	81 Wells	133X133X53	6 Bags/Pack, 2 Packs/Case	972 Vials/Case
89-9205	2.0ml Vials + 2 in Box	External	Purple	81 Wells	133X133X53	6 Bags/Pack, 2 Packs/Case	972 Vials/Case
89-9207	2.0ml Vials + 2 in Box	External	Clear	81 Wells	133X133X53	6 Bags/Pack, 2 Packs/Case	972 Vials/Case
89-9220	2.0ml Vials + 2 in Box	External	White	100 Wells	136X136X53	6 Bags/Pack, 2 Packs/Case	1200 Vials/Case
89-9221	2.0ml Vials + 2 in Box	External	Red	100 Wells	136X136X53	6 Bags/Pack, 2 Packs/Case	1200 Vials/Case
89-9222	2.0ml Vials + 2 in Box	External	Green	100 Wells	136X136X53	6 Bags/Pack, 2 Packs/Case	1200 Vials/Case
89-9223	2.0ml Vials + 2 in Box	External	Blue	100 Wells	136X136X53	6 Bags/Pack, 2 Packs/Case	1200 Vials/Case
89-9224	2.0ml Vials + 2 in Box	External	Yellow	100 Wells	136X136X53	6 Bags/Pack, 2 Packs/Case	1200 Vials/Case
89-9225	2.0ml Vials + 2 in Box	External	Purple	100 Wells	136X136X53	6 Bags/Pack, 2 Packs/Case	1200 Vials/Case
89-9227	2.0ml Vials + 2 in Box	External	Clear	100 Wells	136X136X53	6 Bags/Pack, 2 Packs/Case	1200 Vials/Case
89-9500	5.0ml Vials + 3.75 in Box	External	White	81 Wells	133X133X95	6 Bags/Pack, 2 Packs/Case	972 Vials/Case
89-9501	5.0ml Vials + 3.75 in Box	External	Red	81 Wells	133X133X95	6 Bags/Pack, 2 Packs/Case	972 Vials/Case
89-9502	5.0ml Vials + 3.75 in Box	External	Green	81 Wells	133X133X95	6 Bags/Pack, 2 Packs/Case	972 Vials/Case
89-9503	5.0ml Vials + 3.75 in Box	External	Blue	81 Wells	133X133X95	6 Bags/Pack, 2 Packs/Case	972 Vials/Case
89-9504	5.0ml Vials + 3.75 in Box	External	Yellow	81 Wells	133X133X95	6 Bags/Pack, 2 Packs/Case	972 Vials/Case
89-9505	5.0ml Vials + 3.75 in Box	External	Purple	81 Wells	133X133X95	6 Bags/Pack, 2 Packs/Case	972 Vials/Case
89-9507	5.0ml Vials + 3.75 in Box	External	Clear	81 Wells	133X133X95	6 Bags/Pack, 2 Packs/Case	972 Vials/Case

Multi-Coded Cryogenic Vials



2.0ml Internal Thread,
Bulk Vials

Cat#	Volume	Thread Type	Color	Unit	Total
88-9210	2.0ml	Internal, O-ring	White	25 Sets/Bag, 20 Bags/Pack, 2 Packs/Case	1000 Sets/Case
88-9211	2.0ml	Internal, O-ring	Red	25 Sets/Bag, 20 Bags/Pack, 2 Packs/Case	1000 Sets/Case
88-9212	2.0ml	Internal, O-ring	Green	25 Sets/Bag, 20 Bags/Pack, 2 Packs/Case	1000 Sets/Case
88-9213	2.0ml	Internal, O-ring	Blue	25 Sets/Bag, 20 Bags/Pack, 2 Packs/Case	1000 Sets/Case
88-9214	2.0ml	Internal, O-ring	Yellow	25 Sets/Bag, 20 Bags/Pack, 2 Packs/Case	1000 Sets/Case
88-9215	2.0ml	Internal, O-ring	Purple	25 Sets/Bag, 20 Bags/Pack, 2 Packs/Case	1000 Sets/Case
88-9217	2.0ml	Internal, O-ring	Clear	25 Sets/Bag, 20 Bags/Pack, 2 Packs/Case	1000 Sets/Case

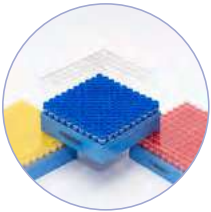

2.0ml Internal
Thread, Racked Vials

Cat#	Volume	Thread Type	Color	Wells	Dimensions(mm)	Unit	Total
89-9210	2.0ml Vials + 2 in Box	Internal, O-ring	White	81 Wells	133X133X53	6 Bags/Pack, 2 Packs/Case	972 Vials/Case
89-9211	2.0ml Vials + 2 in Box	Internal, O-ring	Red	81 Wells	133X133X53	6 Bags/Pack, 2 Packs/Case	972 Vials/Case
89-9212	2.0ml Vials + 2 in Box	Internal, O-ring	Green	81 Wells	133X133X53	6 Bags/Pack, 2 Packs/Case	972 Vials/Case
89-9213	2.0ml Vials + 2 in Box	Internal, O-ring	Blue	81 Wells	133X133X53	6 Bags/Pack, 2 Packs/Case	972 Vials/Case
89-9214	2.0ml Vials + 2 in Box	Internal, O-ring	Yellow	81 Wells	133X133X53	6 Bags/Pack, 2 Packs/Case	972 Vials/Case
89-9215	2.0ml Vials + 2 in Box	Internal, O-ring	Purple	81 Wells	133X133X53	6 Bags/Pack, 2 Packs/Case	972 Vials/Case
89-9217	2.0ml Vials + 2 in Box	Internal, O-ring	Clear	81 Wells	133X133X53	6 Bags/Pack, 2 Packs/Case	972 Vials/Case
89-9230	2.0ml Vials + 2 in Box	Internal, O-ring	White	100 Wells	136X136X53	6 Bags/Pack, 2 Packs/Case	1200 Vials/Case
89-9231	2.0ml Vials + 2 in Box	Internal, O-ring	Red	100 Wells	136X136X53	6 Bags/Pack, 2 Packs/Case	1200 Vials/Case
89-9232	2.0ml Vials + 2 in Box	Internal, O-ring	Green	100 Wells	136X136X53	6 Bags/Pack, 2 Packs/Case	1200 Vials/Case
89-9233	2.0ml Vials + 2 in Box	Internal, O-ring	Blue	100 Wells	136X136X53	6 Bags/Pack, 2 Packs/Case	1200 Vials/Case
89-9234	2.0ml Vials + 2 in Box	Internal, O-ring	Yellow	100 Wells	136X136X53	6 Bags/Pack, 2 Packs/Case	1200 Vials/Case
89-9235	2.0ml Vials + 2 in Box	Internal, O-ring	Purple	100 Wells	136X136X53	6 Bags/Pack, 2 Packs/Case	1200 Vials/Case
89-9237	2.0ml Vials + 2 in Box	Internal, O-ring	Clear	100 Wells	136X136X53	6 Bags/Pack, 2 Packs/Case	1200 Vials/Case



Inserts fit 2.0ml and 5.0ml
vial caps

Cat#	Color	Unit	Total
88-6000	White	100 /Bag, 30 Bags/ Case	3000/Case
88-6001	Red	100 /Bag, 30 Bags/ Case	3000/Case
88-6002	Green	100 /Bag, 30 Bags/ Case	3000/Case
88-6003	Blue	100 /Bag, 30 Bags/ Case	3000/Case
88-6004	Yellow	100 /Bag, 30 Bags/ Case	3000Case
88-6005	Purple	100 /Bag, 30 Bags/ Case	3000/Case
88-6006	Assorted colors	100 /Bag, 30 Bags/ Case	3000/Case

SBS Standard Cryogenic Vials- External Thread



>> Features

- Vials: Made of medical grade polypropylene, autoclavable, 2-Color injection molding technique
Four codes on one vial: Bottom: Laser etched 2D code and human-readable codes; Side: Laser etched 1D barcode and human-readable codes
- Racks: Side: Laser etched 1D barcode, 2D code, and human-readable codes; Bottom: 2D code. Pre-set alphanumeric marks for sample identification. Can be used with CKS-1301 CryoKING scanner to manager samples
- 100,000 grade clean room enables safe vials
- Gamma radiations sterilized; DNase & RNase free, endotoxin free, foreign DNA free
- Stable from -196°C to 121°C, can be stored in vapor phase liquid nitrogen
- Compatible with Micronic cappers & decappers and sample management system

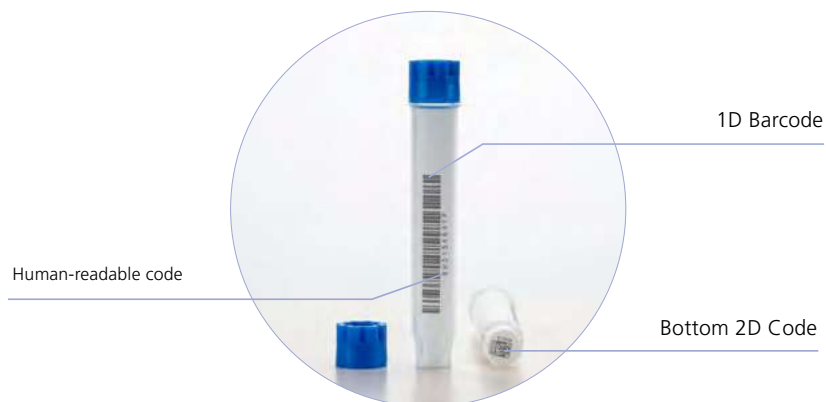

SBS Standard Cryogenic Vials- External Thread



1.4ml External Thread, Bulk Vials

0.75ml External Thread, Bulk Vials

Cat#	Thread Type	Volume	Cap Color	Bottom Barcode	Side code	Sterile	Unit	Total
88-5141	External	1.4ml	Sky blue	Yes	Yes	Yes	96 Sets/Bag, 10 Bags/Pack, 2 Packs/Case	1920 Sets/Case
88-5142	External	1.4ml	Lime green	Yes	Yes	Yes	96 Sets/Bag, 10 Bags/Pack, 2 Packs/Case	1920 Sets/Case
88-5143	External	1.4ml	Biologix blue	Yes	Yes	Yes	96 Sets/Bag, 10 Bags/Pack, 2 Packs/Case	1920 Sets/Case
88-5145	External	1.4ml	Lavender purple	Yes	Yes	Yes	96 Sets/Bag, 10 Bags/Pack, 2 Packs/Case	1920 Sets/Case
88-5081	External	0.75ml	Sky blue	Yes	Yes	Yes	96 Sets/Bag, 10 Bags/Pack, 2 Packs/Case	1920 Sets/Case
88-5082	External	0.75ml	Lime green	Yes	Yes	Yes	96 Sets/Bag, 10 Bags/Pack, 2 Packs/Case	1920 Sets/Case
88-5083	External	0.75ml	Biologix blue	Yes	Yes	Yes	96 Sets/Bag, 10 Bags/Pack, 2 Packs/Case	1920 Sets/Case
88-5085	External	0.75ml	Lavender purple	Yes	Yes	Yes	96 Sets/Bag, 10 Bags/Pack, 2 Packs/Case	1920 Sets/Case
88-5041	External	0.4ml	Sky blue	Yes	Yes	Yes	96 Sets/Bag, 10 Bags/Pack, 2 Packs/Case	1920 Sets/Case
88-5042	External	0.4ml	Lime green	Yes	Yes	Yes	96 Sets/Bag, 10 Bags/Pack, 2 Packs/Case	1920 Sets/Case
88-5043	External	0.4ml	Biologix blue	Yes	Yes	Yes	96 Sets/Bag, 10 Bags/Pack, 2 Packs/Case	1920 Sets/Case
88-5045	External	0.4ml	Lavender purple	Yes	Yes	Yes	96 Sets/Bag, 10 Bags/Pack, 2 Packs/Case	1920 Sets/Case

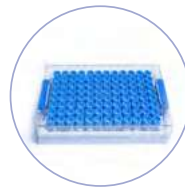
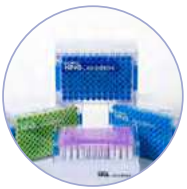

1.4ml External Thread, Racked Vials

0.75ml External Thread, Racked Vials

0.4ml External Thread, Racked Vials

Cat#	Description	Cap Color	Bottom Barcode	Side code	Rack Well	Dimensions (mm)	Unit	Total
89-5141	1.4ml vials +rack	Sky blue	Yes	Yes	96-well, square	128x85x56	10 Bags/Pack, 2 Packs/Case	1920 Sets/Case
89-5142	1.4ml vials +rack	Lime green	Yes	Yes	96-well, square	128x85x56	10 Bags/Pack, 2 Packs/Case	1920 Sets/Case
89-5143	1.4ml vials +rack	Biologix blue	Yes	Yes	96-well, square	128x85x56	10 Bags/Pack, 2 Packs/Case	1920 Sets/Case
89-5145	1.4ml vials +rack	Lavender purple	Yes	Yes	96-well, square	128x85x56	10 Bags/Pack, 2 Packs/Case	1920 Sets/Case
89-5081	0.75ml vials+rack	Sky blue	Yes	Yes	96-well, square	128x85x39	10 Bags/Pack, 2 Packs/Case	1920 Sets/Case
89-5082	0.75ml vials+rack	Lime green	Yes	Yes	96-well, square	128x85x39	10 Bags/Pack, 2 Packs/Case	1920 Sets/Case
89-5083	0.75ml vials+rack	Biologix blue	Yes	Yes	96-well, square	128x85x39	10 Bags/Pack, 2 Packs/Case	1920 Sets/Case
89-5085	0.75ml vials+rack	Lavender purple	Yes	Yes	96-well, square	128x85x39	10 Bags/Pack, 2 Packs/Case	1920 Sets/Case
89-5041	0.4ml vials+rack	Sky blue	Yes	Yes	96-well, square	128x85x32	10 Bags/Pack, 2 Packs/Case	1920 Sets/Case
89-5042	0.4ml vials+rack	Lime green	Yes	Yes	96-well, square	128x85x32	10 Bags/Pack, 2 Packs/Case	1920 Sets/Case
89-5043	0.4ml vials+rack	Biologix blue	Yes	Yes	96-well, square	128x85x32	10 Bags/Pack, 2 Packs/Case	1920 Sets/Case
89-5045	0.4ml vials+rack	Lavender purple	Yes	Yes	96-well, square	128x85x32	10 Bags/Pack, 2 Packs/Case	1920 Sets/Case



Racks for 1.4ml vials

Racks for 0.75ml vials

Racks for 0.4ml vials

Cat#	Vial Volume	Color	Well	Dimensions (mm)	Unit	Total
98-5227	1.4ml	White	96-well, square	128x85x56	10 /Pack, 2 Packs/Case	20 /Case
98-5327	0.75ml	White	96-well, square	128x85x39	10 /Pack, 2 Packs/Case	20 /Case
98-5427	0.4ml	White	96-well, square	128x85x32	10 /Pack, 2 Packs/Case	20 /Case

SBS Standard Cryogenic Vials- External Thread

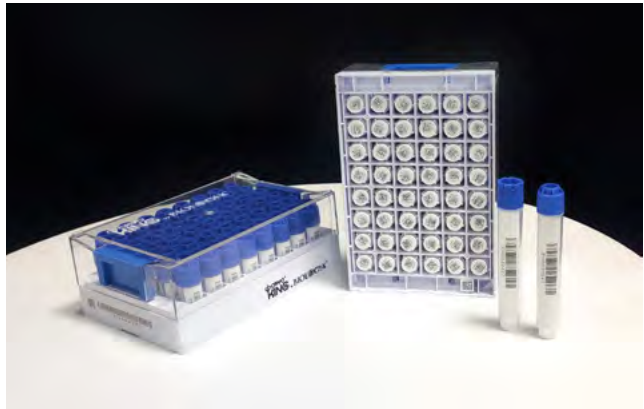

>> Features

- Vials: Made of medical grade polypropylene, autoclavable, 2-Color injection molding technique
Four codes on one vial: Bottom: Laser etched 2D code and human-readable codes; Side: Laser etched 1D barcode and human-readable codes
- Two Cap types: concave cap and domed cap
- Racks: Side: Laser etched 1D barcode, 2D code, and human-readable codes; Bottom: 2D code. Pre-set alphanumeric marks for sample identification. Can be used with CKS-1301 CryoKING scanner to manager samples
- Gamma radiations sterilized; DNase & RNase free, endotoxin free, foreign DNA free
- Stable from -196°C to 121°C, can be stored in vapor phase liquid nitrogen
- Compatible with Micronic cappers & decappers and sample management system



5.0ml External Thread, Bulk Vials



2.0ml External Thread, Bulk Vials



1.0ml External Thread, Bulk Vials



Cat#	Volume	Cap Type	Color	Bottom Barcode	Side Code	Sterile	Unit	Total
88-5101-F	1.0 ml	Concave Cap	Sky Blue	Yes	Yes	Yes	48 /Bag, 10 Bags/Pack, 2 Packs/Case	960 /Case
88-5102-F	1.0 ml	Concave Cap	Lime Green	Yes	Yes	Yes	48 /Bag, 10 Bags/Pack, 2 Packs/Case	960 /Case
88-5103-F	1.0 ml	Concave Cap	Biologix Blue	Yes	Yes	Yes	48 /Bag, 10 Bags/Pack, 2 Packs/Case	960 /Case
88-5105-F	1.0 ml	Concave Cap	Lavender purple	Yes	Yes	Yes	48 /Bag, 10 Bags/Pack, 2 Packs/Case	960 /Case
88-5101-R	1.0 ml	Domed Cap	Sky Blue	Yes	Yes	Yes	48 /Bag, 10 Bags/Pack, 2 Packs/Case	960 /Case
88-5102-R	1.0 ml	Domed Cap	Lime Green	Yes	Yes	Yes	48 /Bag, 10 Bags/Pack, 2 Packs/Case	960 /Case
88-5103-R	1.0 ml	Domed Cap	Biologix Blue	Yes	Yes	Yes	48 /Bag, 10 Bags/Pack, 2 Packs/Case	960 /Case
88-5105-R	1.0 ml	Domed Cap	Lavender purple	Yes	Yes	Yes	48 /Bag, 10 Bags/Pack, 2 Packs/Case	960 /Case
88-5201-F	2.0 ml	Concave Cap	Sky Blue	Yes	Yes	Yes	48 /Bag, 10 Bags/Pack, 2 Packs/Case	960 /Case
88-5202-F	2.0 ml	Concave Cap	Lime Green	Yes	Yes	Yes	48 /Bag, 10 Bags/Pack, 2 Packs/Case	960 /Case
88-5203-F	2.0 ml	Concave Cap	Biologix Blue	Yes	Yes	Yes	48 /Bag, 10 Bags/Pack, 2 Packs/Case	960 /Case
88-5205-F	2.0 ml	Concave Cap	Lavender purple	Yes	Yes	Yes	48 /Bag, 10 Bags/Pack, 2 Packs/Case	960 /Case
88-5201-R	2.0 ml	Domed Cap	Sky Blue	Yes	Yes	Yes	48 /Bag, 10 Bags/Pack, 2 Packs/Case	960 /Case
88-5202-R	2.0 ml	Domed Cap	Lime Green	Yes	Yes	Yes	48 /Bag, 10 Bags/Pack, 2 Packs/Case	960 /Case
88-5203-R	2.0 ml	Domed Cap	Biologix Blue	Yes	Yes	Yes	48 /Bag, 10 Bags/Pack, 2 Packs/Case	960 /Case
88-5205-R	2.0 ml	Domed Cap	Lavender purple	Yes	Yes	Yes	48 /Bag, 10 Bags/Pack, 2 Packs/Case	960 /Case
88-5501-F	5.0 ml	Concave Cap	Sky Blue	Yes	Yes	Yes	48 /Bag, 10 Bags/Pack, 2 Packs/Case	960 /Case
88-5502-F	5.0 ml	Concave Cap	Lime Green	Yes	Yes	Yes	48 /Bag, 10 Bags/Pack, 2 Packs/Case	960 /Case

SBS Standard Cryogenic Vials- External Thread

Cat#	Volume	Cap Type	Color	Bottom Barcode	Side Code	Sterile	Unit	Total
88-5503-F	5.0 ml	Concave Cap	Biologix Blue	Yes	Yes	Yes	48 /Bag, 10 Bags/Pack, 2 Packs/Case	960 /Case
88-5505-F	5.0 ml	Concave Cap	Lavender purple	Yes	Yes	Yes	48 /Bag, 10 Bags/Pack, 2 Packs/Case	960 /Case
88-5501-R	5.0 ml	Domed Cap	Sky Blue	Yes	Yes	Yes	48 /Bag, 10 Bags/Pack, 2 Packs/Case	960 /Case
88-5502-R	5.0 ml	Domed Cap	Lime Green	Yes	Yes	Yes	48 /Bag, 10 Bags/Pack, 2 Packs/Case	960 /Case
88-5503-R	5.0 ml	Domed Cap	Biologix Blue	Yes	Yes	Yes	48 /Bag, 10 Bags/Pack, 2 Packs/Case	960 /Case
88-5505-R	5.0 ml	Domed Cap	Lavender purple	Yes	Yes	Yes	48 /Bag, 10 Bags/Pack, 2 Packs/Case	960 /Case



5.0ml External Thread, Racked Vials



2.0ml External Thread, Racked Vials



1.0ml External Thread, Racked Vials

Cat#	Description	Cap Type	Rack Well	Color	Bottom Barcode	Side Code	Dimensions (mm)	Unit	Total
89-5101-F	1.0 ml vials+rack	Concave Cap	48-well, square	Sky Blue	Yes	Yes	128x85x38.1	10 Sets/Pack, 2 Packs/Case	960 Vials+20 Racks
89-5102-F	1.0 ml vials+rack	Concave Cap	48-well, square	Lime Green	Yes	Yes	128x85x38.1	10 Sets/Pack, 2 Packs/Case	960 Vials+20 Racks
89-5103-F	1.0 ml vials+rack	Concave Cap	48-well, square	Biologix Blue	Yes	Yes	128x85x38.1	10 Sets/Pack, 2 Packs/Case	960 Vials+20 Racks
89-5105-F	1.0 ml vials+rack	Concave Cap	48-well, square	Lavender purple	Yes	Yes	128x85x38.1	10 Sets/Pack, 2 Packs/Case	960 Vials+20 Racks
89-5101-R	1.0 ml vials+rack	Domed Cap	48-well, square	Sky Blue	Yes	Yes	128x85x38.1	10 Sets/Pack, 2 Packs/Case	960 Vials+20 Racks
89-5102-R	1.0 ml vials+rack	Domed Cap	48-well, square	Lime Green	Yes	Yes	128x85x38.1	10 Sets/Pack, 2 Packs/Case	960 Vials+20 Racks
89-5103-R	1.0 ml vials+rack	Domed Cap	48-well, square	Biologix Blue	Yes	Yes	128x85x38.1	10 Sets/Pack, 2 Packs/Case	960 Vials+20 Racks
89-5105-R	1.0 ml vials+rack	Domed Cap	48-well, square	Lavender purple	Yes	Yes	128x85x38.1	10 Sets/Pack, 2 Packs/Case	960 Vials+20 Racks
89-5201-F	2.0 ml vials+rack	Concave Cap	48-well, square	Sky Blue	Yes	Yes	128x85x49.5	10 Sets/Pack, 2 Packs/Case	960 Vials+20 Racks
89-5202-F	2.0 ml vials+rack	Concave Cap	48-well, square	Lime Green	Yes	Yes	128x85x49.5	10 Sets/Pack, 2 Packs/Case	960 Vials+20 Racks
89-5203-F	2.0 ml vials+rack	Concave Cap	48-well, square	Biologix Blue	Yes	Yes	128x85x49.5	10 Sets/Pack, 2 Packs/Case	960 Vials+20 Racks
89-5205-F	2.0 ml vials+rack	Concave Cap	48-well, square	Lavender purple	Yes	Yes	128x85x49.5	10 Sets/Pack, 2 Packs/Case	960 Vials+20 Racks
89-5201-R	2.0 ml vials+rack	Domed Cap	48-well, square	Sky Blue	Yes	Yes	128x85x49.5	10 Sets/Pack, 2 Packs/Case	960 Vials+20 Racks
89-5202-R	2.0 ml vials+rack	Domed Cap	48-well, square	Lime Green	Yes	Yes	128x85x49.5	10 Sets/Pack, 2 Packs/Case	960 Vials+20 Racks
89-5203-R	2.0 ml vials+rack	Domed Cap	48-well, square	Biologix Blue	Yes	Yes	128x85x49.5	10 Sets/Pack, 2 Packs/Case	960 Vials+20 Racks
89-5205-R	2.0 ml vials+rack	Domed Cap	48-well, square	Lavender purple	Yes	Yes	128x85x49.5	10 Sets/Pack, 2 Packs/Case	960 Vials+20 Racks
89-5501-F	5.0 ml vials+rack	Concave Cap	48-well, square	Sky Blue	Yes	Yes	128x85x86	6 Sets/Pack, 2 Packs/Case	576 Vials+12 Racks
89-5502-F	5.0 ml vials+rack	Concave Cap	48-well, square	Lime Green	Yes	Yes	128x85x86	6 Sets/Pack, 2 Packs/Case	576 Vials+12 Racks
89-5503-F	5.0 ml vials+rack	Concave Cap	48-well, square	Biologix Blue	Yes	Yes	128x85x86	6 Sets/Pack, 2 Packs/Case	576 Vials+12 Racks
89-5505-F	5.0 ml vials+rack	Concave Cap	48-well, square	Lavender purple	Yes	Yes	128x85x86	6 Sets/Pack, 2 Packs/Case	576 Vials+12 Racks
89-5501-R	5.0 ml vials+rack	Domed Cap	48-well, square	Sky Blue	Yes	Yes	128x85x86	6 Sets/Pack, 2 Packs/Case	576 Vials+12 Racks
89-5502-R	5.0 ml vials+rack	Domed Cap	48-well, square	Lime Green	Yes	Yes	128x85x86	6 Sets/Pack, 2 Packs/Case	576 Vials+12 Racks
89-5503-R	5.0 ml vials+rack	Domed Cap	48-well, square	Biologix Blue	Yes	Yes	128x85x86	6 Sets/Pack, 2 Packs/Case	576 Vials+12 Racks
89-5505-R	5.0 ml vials+rack	Domed Cap	48-well, square	Lavender purple	Yes	Yes	128x85x86	6 Sets/Pack, 2 Packs/Case	576 Vials+12 Racks



Racks for 5.0ml vials



Racks for 2.0ml vials



Racks for 1.0ml vials

Cat#	Vial Volume	Color	Well	Dimensions (mm)	Unit	Total
98-5527	1.0 ml	White	48-well, square	128x85x38.1	12 /Pack, 2 Packs/Case	24 /Case
98-5627	2.0 ml	White	48-well, square	128x85x49.5	12 /Pack, 2 Packs/Case	24 /Case
98-5727	5.0 ml	White	48-well, square	128x85x86	6 /Pack, 2 Packs/Case	12 /Case

SBS Standard Cryogenic Vials- Internal Thread

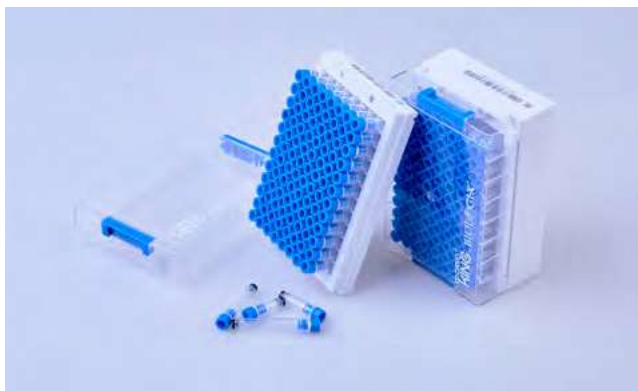

>> Features

- 2D barcodes on 96-well format cryogenic vials are easy to be read
- 2D barcode and Human-readable code on the side of SBS format racks; 2D barcode at the bottom of racks, cryogenic vials and racks can be traced at the same time
- Simple and powerful mechanical locking function, slide the buttons on both sides to unlock
- Laser etched 2D barcodes, resistant to DMSO and other organic solvents
- SBS format rack fits 96-well format cryogenic vials perfectly for automatic operations

Specifications

- Working temperature: stable from -196°C to 121°C, autoclavable
- Suitable for liquid nitrogen freezing(vapor phase)



Bulk Vials



Cat#	Thread Type	Volume	Color	Bottom Barcode	Writing Area	Sterile	Unit	Total
88-4033	Internal	0.3ml	Blue	Yes	No	Yes	96 Sets/Bag, 10 Bags/Pack, 2 Packs/Case	1920 Sets/Case
88-4053	Internal	0.5ml	Blue	Yes	No	Yes	96 Sets/Bag, 10 Bags/Pack, 2 Packs/Case	1920 Sets/Case
88-4083	Internal	0.75ml	Blue	Yes	No	Yes	96 Sets/Bag, 10 Bags/Pack, 2 Packs/Case	1920 Sets/Case
88-4103	Internal	1.0ml	Blue	Yes	No	Yes	96 Sets/Bag, 10 Bags/Pack, 2 Packs/Case	1920 Sets/Case



0.3ml & 0.5ml Internal Thread, Racked Vials

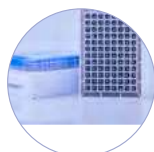

0.75ml & 1.0ml Internal Thread, Racked Vials

Cat#	Description	Cap Col or	Bottom Barcode	Side Barcode	Rack Well	Dimensions(mm)	Unit	Total
89-4233	0.3ml vials +rack	Blue	Yes	No	96-well, square	128 x 85 x 35	10 Bags/Pack, 2 Packs/Case	1920 Sets/Case
89-4253	0.5ml vials +rack	Blue	Yes	No	96-well, square	128 x 85 x 35	10 Bags/Pack, 2 Packs/Case	1920 Sets/Case
89-4283	0.75ml vials +rack	Blue	Yes	No	96-well, square	128 x 85 x 54	10 Bags/Pack, 2 Packs/Case	1920 Sets/Case
89-4213	1.0ml vials +rack	Blue	Yes	No	96-well, square	128 x 85 x 54	10 Bags/Pack, 2 Packs/Case	1920 Sets/Case

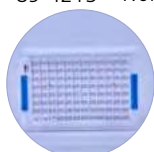

SBS Format Cryogenic Racks

Cat#	Vial Volume	Color	Well	Dimensions(mm)	Unit	Total
98-4127	0.3ml & 0.5ml	White	96-well, square	128 x 85 x 35	10 /Pack, 2 Packs/Case	20 /Case
98-4227	0.75ml & 1.0ml	White	96-well, square	128 x 85 x 54	10 /Pack, 2 Packs/Case	20 /Case

Cardboard Cryogenic Boxes



>> Features

- Made of durable cardboard with superior white outer coating
- Chemically resistant to alcohols and mild organic solvents
- Five assorted colors available: white, yellow, pink, blue, and green
- White premium cardboard freezer boxes have a glossy coating, other colors have a matte coating
- Water resistant coating for improved durability
- Superior white 90-1281 & 90-1200 cardboard cryogenic boxes without outer coating are also available
- Holds 0.5ml, 1.5ml, 2.0ml, 5ml and 10ml tubes and 15ml or 50ml Centrifuge Tubes

Specifications

- Working temperature: stable from -196°C to 121°C
- Suitable for liquid nitrogen freezing(vapor phase)



Label area



Cat #	Height	Wells	Color	Coating	Dimensions (mm)	Unit	Total
90-1200	2 in	100-well	White	No	132 x 132 x 53	5 /Bag, 20 Bags/Case	100 /Case
90-1281	2 in	81-well	White	No	132 x 132 x 53	5 /Bag, 20 Bags/Case	100 /Case
90-1300	3 in	100-well	White	No	133 x 133 x 76	5 /Bag, 20 Bags/Case	100 /Case
90-1381	3 in	81-well	White	No	133 x 133 x 76	5 /Bag, 20 Bags/Case	100 /Case
90-2281	2 in	81-well	White	Plastic coating	133 x 133 x 53	5 /Bag, 20 Bags/Case	100 /Case
90-2200	2 in	100-well	White	Plastic coating	133 x 133 x 53	5 /Bag, 20 Bags/Case	100 /Case
90-5281	2 in	81-well	Assorted color	Matte coating	133 x 133 x 53	5 /Bag, 20 Bags/Case	100 /Case
90-5200	2 in	100-well	Assorted color	Matte coating	133 x 133 x 53	5 /Bag, 20 Bags/Case	100 /Case
90-2381	3 in	81-well	White	Plastic coating	133 x 133 x 76	5 /Bag, 20 Bags/Case	100 /Case
90-2300	3 in	100-well	White	Plastic coating	133 x 133 x 76	5 /Bag, 20 Bags/Case	100 /Case
90-5016	-	16-well	White	No	For 50ml tubes	5 /Bag, 20 Bags/Case	100 /Case
90-1536	-	36-well	White	No	For 15ml tubes	5 /Bag, 20 Bags/Case	100 /Case

ID-Color™ Cardboard Cryogenic Boxes



>> Features

- Made of durable cardboard with a waterproof coating and polypropylene dividers
- Connected lid design ensures that lids are never misplaced or mixed up
- Alphanumeric labeling featured on the lid, bottom and four sides enables quick and easy identification of samples
- Holds 0.5ml/1.5ml/2.0ml/5.0ml microtubes and cryogenic vials

Specifications

- Working temperature: stable from -86°C to 121°C
- Suitable for liquid nitrogen freezing(vapor phase)
(after adding vent holes, and using cardboard dividers)

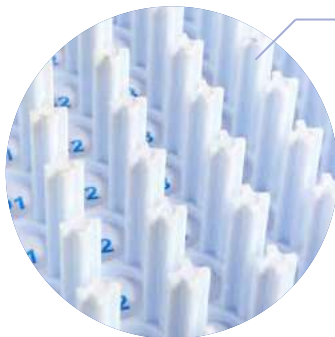

Post-style dividers
100-Well

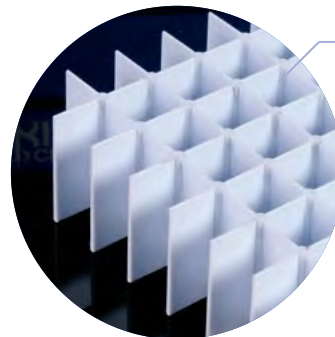

Straight grid divider
design, resistant to low
temperature
81-Well

Cat #	Height	Well	Color	Divider Material	Divider Type	Dimensions (mm)	Unit	Total
90-8100	1in	100-well	Blue	PP	post-style	133 x 133 x 36	5 /Bag, 4 Bags/Case	20 /Case
90-8281	2in	81-well	Assorted color	PP	straight grid	133 x 133 x 53	5 /Bag, 4 Bags/Case	20 /Case
90-8200	2in	100-well	Assorted color	PP	post-style	133 x 133 x 53	5 /Bag, 4 Bags/Case	20 /Case
90-8381	3.75in	81-well	Blue	PP	straight grid	133 x 133 x 95	5 /Bag, 4 Bags/Case	20 /Case

*1in boxes fit for 0.5ml vials

*2in boxes fit for 1.5ml, 2.0ml vials

*3.75in boxes fit for 5.0ml vials

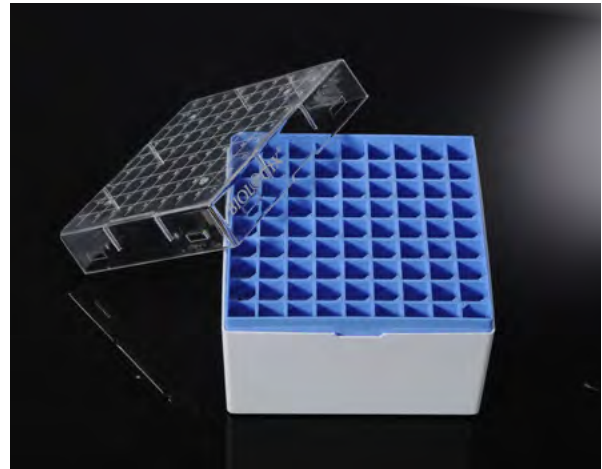

>> Features

- Made of tough polycarbonate, chemically resistant to alcohols and mild organic solvents
- Can be repeatedly frozen and thawed
- 5x5 (25-well), 9x9 (81-well), or 10x10 (100-well) boxes available
- Compatible with 0.5ml, 1.5ml, 2.0ml or 5.0ml microtubes and cryogenic vials
- Numbered grids for sample identification
- Drain holes and air vents minimize condensation
- Five assorted colors available

Specifications

- Suitable for storage in freezers or liquid nitrogen(vapor phase)
- Working temperature: stable from -196°C to 121°C



90-9210

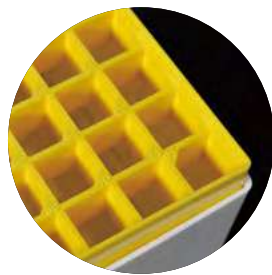

90-9009

Numbers for convenient sample organization

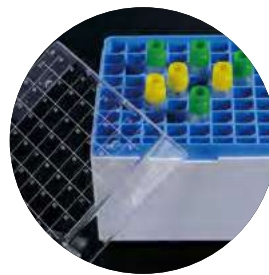

90-9381

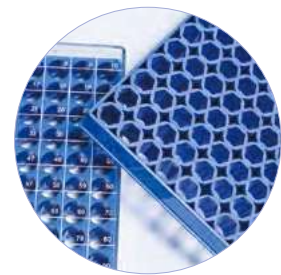

98-series, bottom holes
for bottom coded vials

Cat #	Height	Wells	Color	Dimensions (mm)	Unit	Total
90-9009	2 in	81-well	Assorted Colors	133 x 133 x 53	5 /Bag, 4 Bags/Case	20 /Case
90-9210	2 in	100-well	Assorted Colors	133 x 133 x 53	5 /Bag, 4 Bags/Case	20 /Case
90-9250	2 in	25-well	Assorted Colors	75 x 75 x 53	5 /Bag, 6 Bags/Case	30 /Case
90-9381	3.75 in	81-well	Assorted Colors	133 x 133 x 95	5 /Bag, 4 Bags/Case	20 /Case
98-0113	1 in	100-well	Blue	133 x 133 x 36	3 /Bag, 4 Bags/Case	12 /Case
98-0200	2 in	100-well	Blue	136 x 136 x 53	3 /Bag, 4 Bags/Case	12 /Case
98-0213	2 in	100-well	Blue	133 x 133 x 53	3 /Bag, 4 Bags/Case	12 /Case
98-0313	3.75 in	81-well	Blue	133 x 133 x 95	3 /Bag, 4 Bags/Case	12 /Case
98-1213	2 in	81-well	Blue	133 x 133 x 53	3 /Bag, 4 Bags/Case	12 /Case

*1in boxes fit for 0.5ml vials

*2in boxes fit for 1.5ml,2.0ml vials

*3.75in boxes fit for 5.0ml vials

PP Cryogenic Boxes



>> Features

- Made of polypropylene, chemically resistant to alcohols and mild organic solvents, autoclavable
- Can be repeatedly frozen and thawed
- 5x5 (25-well), 9x9 (81-well), or 10x10 (100-well) boxes available
- Compatible with 0.5ml, 1.5ml or 2.0ml microtubes and cryogenic vials
- Numbered grids for sample identification
- Drain holes and air vents minimize condensation
- Five assorted colors available

Specifications

- Suitable for storage in freezers
- Working temperature: stable from -86°C to 121°C

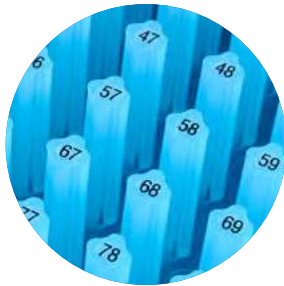

90-9200



90-9100
(with hinged lid)

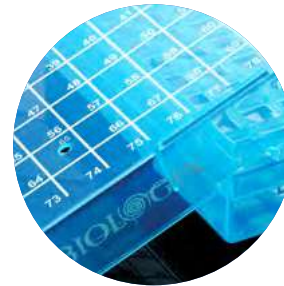

90-9081

Numbers for convenient sample organization

Cat #	Height	Wells	Color	Dimensions (mm)	Unit	Total
90-9025	2 in	25-well	Assorted Colors	75 x 75 x 53	5 /Bag, 6 Bags/Case	30 /Case
90-9081	2 in	81-well	Assorted Colors	133 x 133 x 53	5 /Bag, 4 Bags/Case	20 /Case
90-9100	2 in	100-well	Assorted Colors	141 x 154 x 55	5 /Bag, 4 Bags/Case	20 /Case
90-9200	2 in	100-well	Assorted Colors	133 x 133 x 53	5 /Bag, 4 Bags/Case	20 /Case

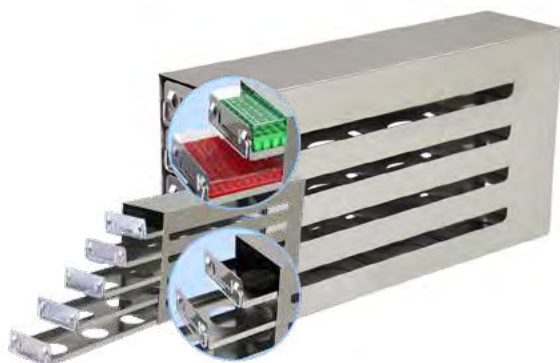

Upper Access Drawer Freezer Racks



Frame Type Freezer Racks

>> Features

Upper Access Drawer Freezer Racks

- Made of corrosion-resistant stainless steel
- Ideal for storage of 1 inch and 2 inch standard size cryogenic boxes
- Fits most standard upright freezers
- Sliding Drawer Freezer Racks include folded rails to reduce frost
- Flanging design reduces scratching
- Handle design enables easy removal from the shelf
- Colored labels for drawer/sample identification
- Can be customized

Frame Type Freezer Racks

- Made of corrosion-resistant stainless steel
- Ideal for storage of 1 inch and 2 inch standard size cryogenic boxes
- Fits most standard upright freezers
- Simple structure and lightweight design helps manage cryogenic boxes efficiently
- Can be customized

Cat#	Description	Capacity (D x H Configuration)	Dimensions(mm) (D x W x H)	Storage box size (mm)
99-7215	Sliding Drawer	3 x 5	420 x 140 x 290	133 x 133 x 53
99-7216	Sliding Drawer	4 x 4	550 x 140 x 232	133 x 133 x 53
99-7220	Sliding Drawer	4 x 5	550 x 140 x 290	133 x 133 x 53
99-7224	Sliding Drawer	4 x 6	550 x 140 x 348	133 x 133 x 53
99-7225	Sliding Drawer	5 x 5	675 x 140 x 290	133 x 133 x 53
99-7228	Sliding Drawer	4 x 7	550 x 140 x 406	133 x 133 x 53
99-2212	Frame Type	3 x 4	420 x 140 x 235	133 x 133 x 53
99-2215	Frame Type	3 x 5	420 x 140 x 290	133 x 133 x 53
99-2216	Frame Type	4 x 4	560 x 140 x 235	133 x 133 x 53
99-2220	Frame Type	4 x 5	560 x 140 x 290	133 x 133 x 53
99-2224	Frame Type	4 x 6	560 x 140 x 340	133 x 133 x 53
99-2225 [#]	Frame Type	5 x 5	680 x 137 x 284	133 x 133 x 52
99-2230	Frame Type	5 x 6	685 x 140 x 340	133 x 133 x 53

[#]: new types and new dimensions will available once old style is sold out, check with us before ordering.

Freezer Racks



Side Access Drawer Freezer Racks



Vertical Type Freezer Racks

>> Features

Side Access Drawer Freezer Racks

- Made of corrosion-resistant stainless steel
- Ideal for storage of 1 inch and 2 inch standard size cryogenic boxes
- Fits most standard upright freezers
- Can be customized

Vertical Type Freezer Racks

- Made of corrosion-resistant stainless steel
- Ideal for storage of 1 inch and 2 inch standard size cryogenic boxes
- Fits most standard horizontal freezers
- Especially suitable for liquid nitrogen freezing
- Can be customized

Cat#	Description	Capacity (D x H Configuration)	Dimensions(mm) (D x W x H)	Storage box size (mm)
99-5212	Side Access Drawer	3 x 4	420 x 140 x 240	133 x 133 x 53
99-5215	Side Access Drawer	3 x 5	420 x 140 x 295	133 x 133 x 53
99-5216	Side Access Drawer	4 x 4	560 x 140 x 240	133 x 133 x 53
99-5220	Side Access Drawer	4 x 5	560 x 140 x 295	133 x 133 x 53
99-5224	Side Access Drawer	4 x 6	560 x 140 x 350	133 x 133 x 53
99-5225 [#]	Side Access Drawer	5 x 5	700 x 140 x 300	133 x 133 x 52
99-6206	Vertical Type	1 x 6	142 x 140 x 345	133 x 133 x 53
99-6207	Vertical Type	1 x 7	142 x 140 x 400	133 x 133 x 53
99-6208	Vertical Type	1 x 8	142 x 140 x 458	133 x 133 x 53
99-6209 [#]	Vertical Type	1 x 9	140 x 140 x 506	133 x 133 x 52
99-6210 [#]	Vertical Type	1 x 10	140 x 140 x 562	133 x 133 x 52
99-6211 [#]	Vertical Type	1 x 11	140 x 140 x 618	133 x 133 x 52
99-6212 [#]	Vertical Type	1 x 12	140 x 140 x 674	133 x 133 x 52
99-6213 [#]	Vertical Type	1 x 13	140 x 140 x 730	133 x 133 x 52

[#]: new types and new dimensions will available once old style is sold out, check with us before ordering.

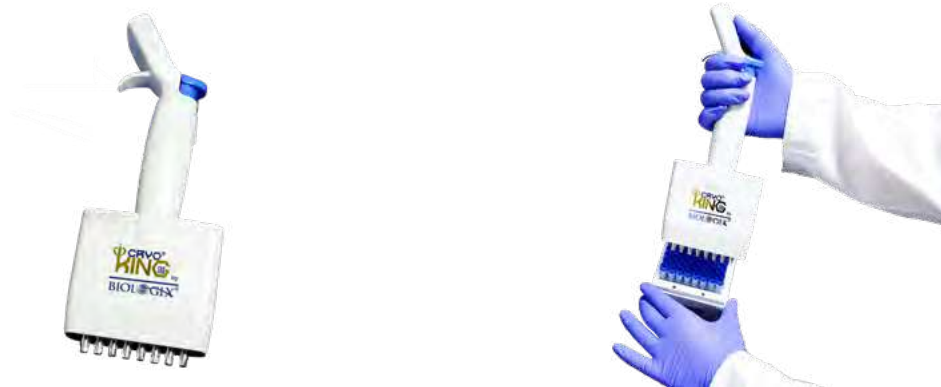

>> Features

- Easy-to-use design: Caps or decaps 8/6 tubes in an individual line. One-hand operation
- Convenient operation: Improves processing throughput of manual procedures with automated column-wise decapping and capping in just 3 seconds
- Optimal torque level: Ensures reproducibility by capping decapping all tubes to the optimal torque level
- Ergonomic design: Light weight, easy-to-use and ergonomic design
- Extra-long standby time: Enhances the convenience of actual operation
- Low noise: Enables the capping /decapping noise less than 5 decibels

Cat #	Adapter Import	Continual Operation	Standby Time	Multi-Channel Screw Cap Capping/Decapping	External Dimension (L*W*H)	Thread Type
CKS-4008	110V-240V, 50-60Hz	5H	30 Days	3S	95mm x 46mm x 255mm	Internal Thread
CKS-5008	110V-240V, 50-60Hz	5H	30 Days	3S	95mm x 46mm x 255mm	External Thread
CKS-5006R	110V-240V, 50-60Hz	5H	30 Days	3S	95mm x 46mm x 255mm	External Thread (Domed Cap)



>> Features

- Capping/decapping all cryogenic vials in 48 or 96-well racks within 15S to 30S
- Drawer-type input/output ports to reduce the risk of contamination
- Cap decapper can be customized for different brands' racks
- Compact design allows it to be placed on the desktop to form an automated work line with other equipments
- Touch screen and navigation design, easy for operation
- Accurate torque ensures the optimal position of opening/closing of the cap, reducing component wear

Cat #	Power	Working temperature	Dimensions	Weight	Capping time	Decapping time	Thread Type
CKS-4096	220V,50Hz	-20°C ~45°C	220 x 320 x 370mm	12KG	≤30S	≤15S	Internal Thread
CKS-5096	220V,50Hz	-20°C ~45°C	220 x 320 x 370mm	12KG	≤30S	≤15S	External Thread



CryoKING Handheld Scanner

- Infrared scanning individual cryogenic vials to identify barcodes and 2D barcodes accurately
- Ergonomic handheld design
- Compatible with CryoKING Crown biobanking management software
- Collect sample information rapidly and accurately
- USB interface

Cat #	Description	Scan Type
CKS-0101	Wired Handheld Scanner Gun	Individual Vial

CryoKING Scanner-3.0

CryoKING scanner-3.0 is a high-speed camera-based barcode scanner designed for biobanks and ultra-low temperature (-20°C) cryobox scanning. It captures the human-readable barcode and bottom barcode and provides 2D data output in a variety of options for your database.



>> Features

- Scans one rack in less than 3 seconds; Camera-based decoding technology
- Project based workflow for easy rack type changes
- Detects missing tubes, advanced error handling options
- Integration friendly design; Rack orientation sensor included
- Working temperature: -4°F to 95°F (-20°C to 35°C)
- SDK toolkit for integration projects is available

Cat#	Dimension	Weight
CKS-1301	8.25" D x 6.25" W x 11.5" H 21 cm x 16 cm x 29 cm	8 lbs.(3.68kg)
Electrical: 100-240VAC~50/60Hz, 1.25A; Universal power supply with US, UK, Euro, or user specified.		
Environment: -4°F to 95°F (-20°C to 35°C).		
System Requirements: Windows 10, 8, 7, Vista; USB 2.0 port(s). Two USB ports.		
CryoKING Scanner 3.0 Includes a 1 Year Warranty.		

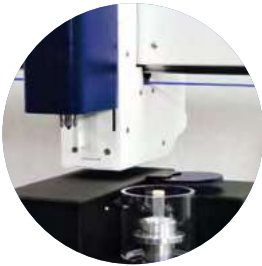

Weigh Tubes



Re-array, reformat tubes

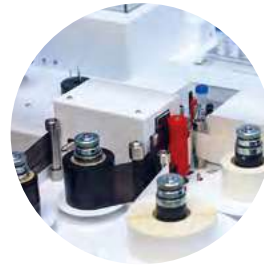

Label Printing and Application



Decode 2D barcodes

Cat #	Capacity	Modules	Dimensions (mm)	Weight
CKS-1520	20 SBS Racks	Standard: Re-array, reformat tubes; Decode 2D barcodes, weigh tubes	72 x 53 x 40 cm	27 kg



Customized Solutions
Professional Consulting Service
Efficient After-sale Service

Biobanking Management Software

CryoKING Crown biobanking management software offers two data storage solutions: Public Cloud and Private Cloud. The convenient operation, visual interface, and standard biobanking procedures enable convenient, standard and traceable biobanking management. CryoKING Crown is an optimal choice for biobanking management, query or statistic in scientific research.

>> Features

- Web/Server structure enables the direct access with the browser
- Visual sample management
- Auto alarming settings
- Convenient information query
- Efficient approval settings
- Batch import of sample information

Low Temperature Freezers



Suitable for blood banks, hospitals, sanitation and antiepidemic stations and clinics, electronic industries, university laboratories, military industries, pelagic fishery companies, and drugstores.

-150°C Cryo Freezer

-86°C Ultra Low Freezer

-60°C Ultra Low Freezer

-40°C Ultra Low Freezer

-25°C Medical Freezer

Combined Refrigerator & Freezer

2 ~ 8°C Medical Refrigerator

4°C Blood Bank Refrigerator

20~24°C platelet incubator

Mobile Cooler





Made of high quality stainless steel or durable aluminum; intelligent monitoring system and multi alarms to ensure the safety of samples. Different types can be chosen according to different storage requirements.

Filling Series

Transport Series

Air Transport Series

Special Transport Series

Static Storage Series

Biobank Series

Portable Dewar Series

Laboratory Series



General Laboratory Supplies

The General Laboratory Supplies section includes many consumables commonly used in basic laboratory and medical procedures. From centrifuge tubes and test tubes to disposable gloves and microscope slides, many of these general laboratory supplies may have applications in multiple life science fields.

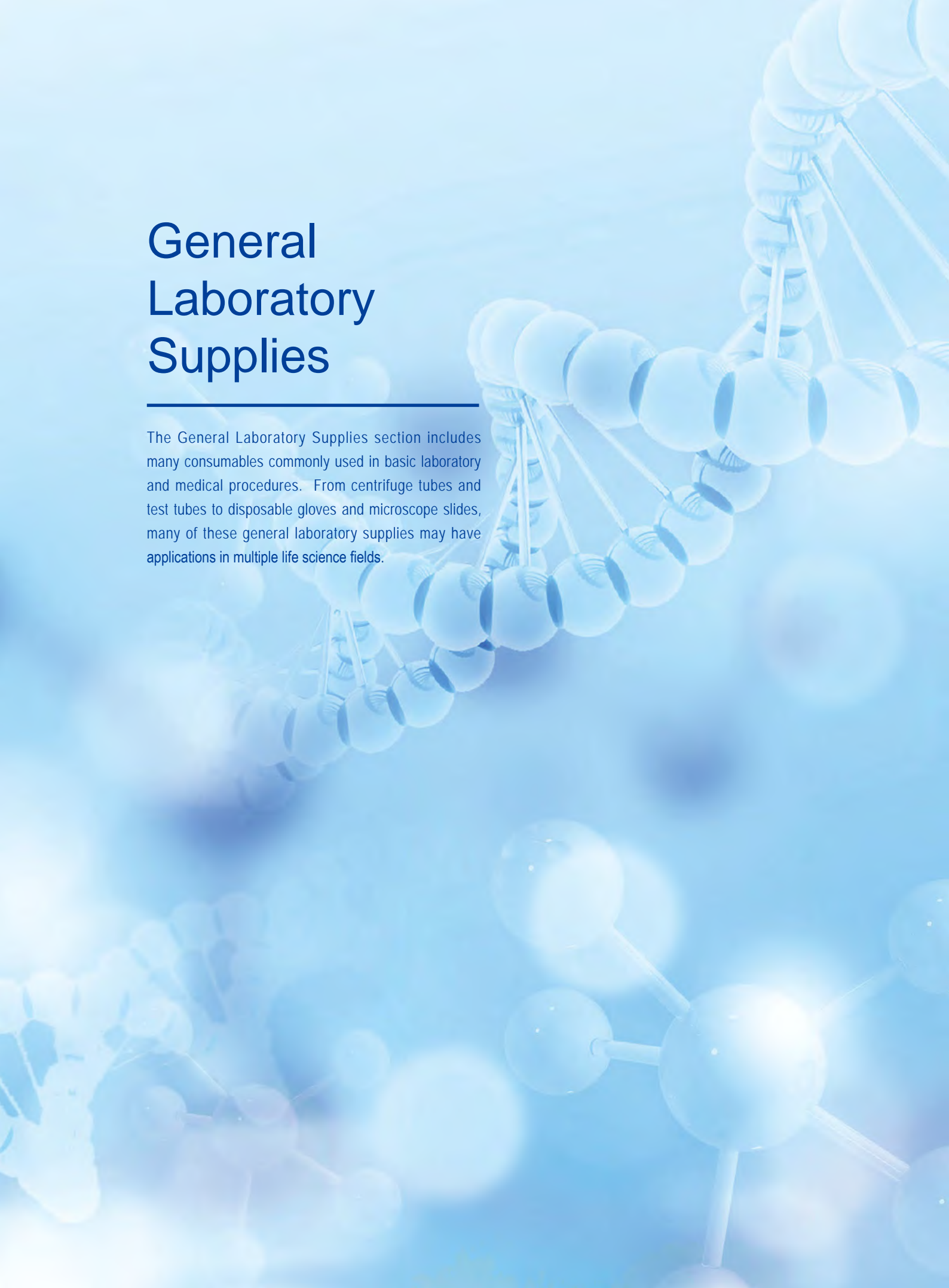

Microcentrifuge Tubes



>> Features

- Made of high quality medical grade polypropylene, autoclavable
- Transparent tube walls permit easy viewing of contents
- Beveled lip for convenient one-handed operation
- Writing area and attached flat cap for labeling

Specifications

- Working temperature: stable from -20°C to 121°C
- Can withstand high speed centrifugation of 20,000 G

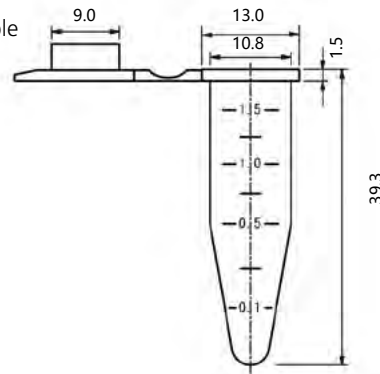

Dimensions = mm

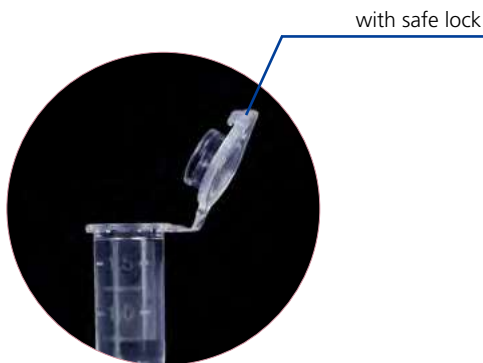

80-0015



80-1500

Cat #	Volume	Color	Sterile	Type	RNase & DNase free	Unit	Total
80-0500	0.5ml	Clear	No	With Safe Lock	Yes	500 /Bag/Pack, 10 Packs/Case	5000 /Case
80-0015	1.5ml	Clear	No	With Safe Lock	Yes	500 /Bag/Pack, 10 Packs/Case	5000 /Case
80-1500	1.5ml	Clear	No	Without Safe Lock	Yes	500 /Bag/Pack, 10 Packs/Case	5000 /Case
80-1500-S	1.5ml	Clear	Yes	Without Safe Lock	Yes	500 /Bag/Pack, 10 Packs/Case	5000 /Case
80-0020	2.0ml	Clear	No	With Safe Lock	Yes	500 /Bag/Pack, 10 Packs/Case	5000 /Case
80-1501*	1.5ml	Red	No	Without Safe Lock	Yes	500 /Bag/Pack, 10 Packs/Case	5000 /Case
80-1502*	1.5ml	Yellow	No	Without Safe Lock	Yes	500 /Bag/Pack, 10 Packs/Case	5000 /Case
80-1503*	1.5ml	Blue	No	Without Safe Lock	Yes	500 /Bag/Pack, 10 Packs/Case	5000 /Case

* MOQ required, Call for details

Tube Racks



Microcentrifuge Tube Racks



PP Centrifuge Tube Racks

>> Features

Microcentrifuge Tube Racks

- Made of high strength plastic, chemically resistant to alcohols and mild organic solvents
- Writing area on side of rack for easy marking
- Handles on each end for secure handling
- 5x16 array, 80 wells, molded with a numeric grid for easy tube identification
- Fit for 1.5ml, 2.0ml microcentrifuge tubes and screw cap tubes

PP Centrifuge Tube Racks

- Made of high quality medical grade polypropylene
- 50-well racks hold 15ml centrifuge tubes
- 25-well racks hold 50ml centrifuge tubes
- Sturdy design keeps tubes upright

Cardboard Centrifuge Tube Racks

- Made of durable cardboard with superior white coating, chemically resistant to alcohols and mild organic solvents
- 36-well racks for 15ml centrifuge tubes, 16-well racks for 50ml centrifuge tubes
- Removable lid features a lined writing area



Cardboard Centrifuge Tube Rack
Working temperature:
from -196 °C to 121°C

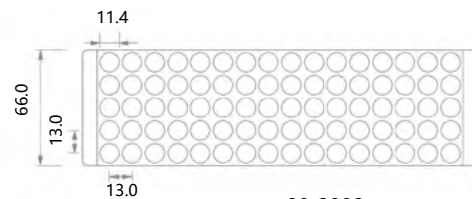
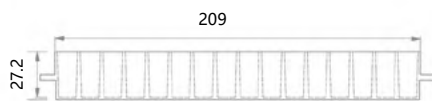

90-8009

Dimensions = mm

Cat #	Well	Color	Sterile	Unit	Total
90-8009	80-well	Assorted Colors	No	5 /Bag, 4 Bags/Case	20 /Case
90-1536	36-well	White	No	5 /Bag, 20 Bags/Case	100 /Case
90-5016	16-well	White	No	5 /Bag, 20 Bags/Case	100 /Case
90-1550	50-well	Blue	No	1 /Bag, 20 Bags/Case	20 /Case
90-5025	25-well	Blue	No	1 /Bag, 20 Bags/Case	20 /Case

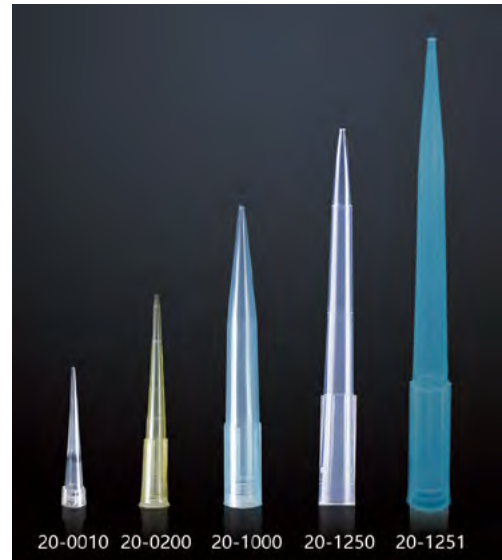

>> Features

- Made of polypropylene, autoclavable
- Available in 10µl, 200µl, 1000µl, 5ml, and 10ml sizes, suitable for standard manual and electronic pipettes
- 10µl and 200µl tips are graduated, 200µl tips have a beveled point design that reduces sample retention
Extended 1000µl tips facilitate pipetting from deep or narrow containers
- RNase & DNase free, non-pyrogenic
- Available in racked package (sterile) and bulk package (non-sterile)

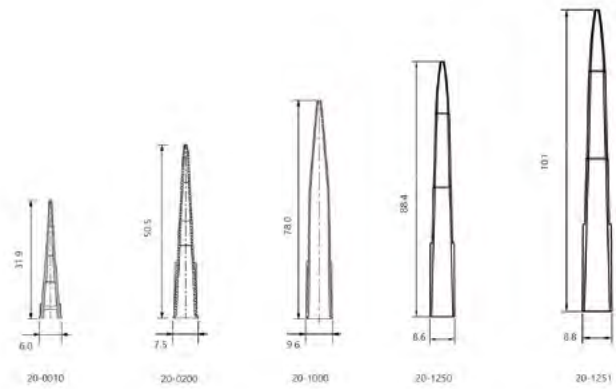

Dimensions = mm

Cat #	Volume	Color	Sterile	Unit	Total
20-0010	10µl	Natural	No	1,000 /Bag, 2 Bags /Pack, 5 Packs/Case	10000 /Case
21-0010	10µl	Natural	Yes	96 /Rack, 10 Racks/Pack, 10 Packs/Case	9600 /Case
20-0200	200µl	Yellow	No	1,000 /Bag/Pack, 10 Packs/Case	10000 /Case
21-0200	200µl	Yellow	Yes	96 /Rack, 10 Racks/Pack, 10 Packs/Case	9600 /Case
20-1000	1000µl	Blue	No	1,000 /Bag/Pack, 10 Packs/Case	10000 /Case
21-1000	1000µl	Blue	Yes	100 /Rack, 6 Racks/Pack, 10 Packs/Case	6000 /Case
20-1250	1000µl Extended	Natural	No	1,000 /Bag/Pack, 10 Packs/Case	10000 /Case
21-1250	1000µl Extended	Natural	Yes	96 /Rack, 6 Racks/Pack, 10 Packs/Case	5760 /Case
20-1251	1000µl Extra-Long	Blue	No	1,000 /Bag/Pack, 10 Packs/Case	10000 /Case
21-5000ES	5ml	Natural	Yes	24 /Rack, 30 Racks/Case	720 /Case
20-5000ES	5ml	Natural	No	100 /Bag, 20 Bags/Case	2000 /Case
21-1100ES	10ml	Natural	Yes	24 /Rack, 40 Racks/Case	960 /Case
20-1100ES	10ml	Natural	No	100 /Bag, 10 Bags/Case	1000 /Case
21-5000TS	5ml	Natural	Yes	40 /Rack, 40 Racks/Case	1600 /Case
20-5000TS	5ml	Natural	No	100 /Bag, 20 Bags/Case	2000 /Case
21-1100TS	10ml	Natural	Yes	24 /Rack, 40 Racks/Case	960 /Case
20-1100TS	10ml	Natural	No	100 /Bag, 10 Bags/Case	1000 /Case

Filter Tips-Bulk Pack



>> Features

- Made in Bioclean room
- Extremely straight low retention tips ensure accurate and precise sample
- Extra-long tips: 10µl with max volume 20µl, 200µl with max volume 300µl, and 1000µl with max volume 1250µl
- Bulk filter tips, non-sterile
- DNase & RNase free, non-pyrogen
- User-friendly label on the tip rack
- Materials: Tips are made of PP, filters are made of UHMWPE with pore size 0.22µm

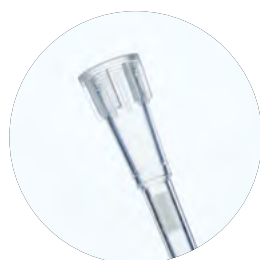

Dimensions = mm

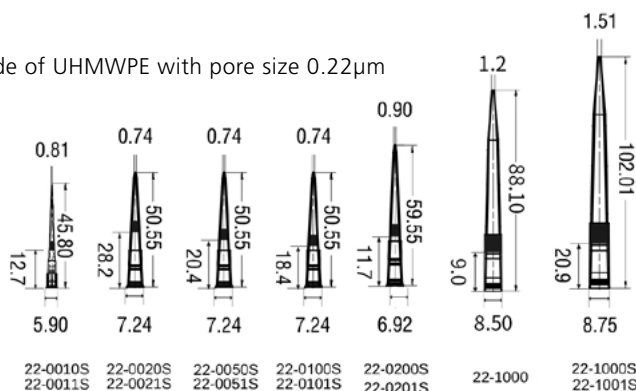

Cat #	Volume	Color	Sterile	Low Retention	Unit	Total
22-0010S	10µl Extended	Natural	No	No	1000 Tips/Bag, 40 Bags/Case	40000 Tips/Case
22-0011S	10µl Extended	Natural	No	Yes	1000 Tips/Bag, 40 Bags/Case	40000 Tips/Case
22-0020S	20µl	Yellow	No	No	1000 Tips/Bag, 20 Bags/Case	20000 Tips/Case
22-0021S	20µl	Natural	No	Yes	1000 Tips/Bag, 20 Bags/Case	20000 Tips/Case
22-0050S	50µl	Natural	No	No	1000 Tips/Bag, 20 Bags/Case	20000 Tips/Case
22-0051S	50µl	Natural	No	Yes	1000 Tips/Bag, 20 Bags/Case	20000 Tips/Case
22-0100S	100µl	Natural	No	No	1000 Tips/Bag, 20 Bags/Case	20000 Tips/Case
22-0101S	100µl	Natural	No	Yes	1000 Tips/Bag, 20 Bags/Case	20000 Tips/Case
22-0200S	200µl Extended	Natural	No	No	1000 Tips/Bag, 20 Bags/Case	20000 Tips/Case
22-0201S	200µl Extended	Natural	No	Yes	1000 Tips/Bag, 20 Bags/Case	20000 Tips/Case
22-1000	1000µl	Blue	No	No	1000 Tips/Bag/Pack, 10 Packs/Case	10000 Tips/Case
22-1000S	1000µl Extended	Natural	No	No	1000 Tips/Bag, 10 Bags/Case	10000 Tips/Case
22-1001S	1000µl Extended	Natural	No	Yes	1000 Tips/Bag, 10 Bags/Case	10000 Tips/Case
22-5000ES	5ml	Natural	No	No	100 /Bag, 20 Bags/Case	2000 /Case
22-1100ES	10ml	Natural	No	No	100 /Bag, 10 Bags/Case	1000 /Case
22-5000TS	5ml	Natural	No	No	100 /Bag, 20 Bags/Case	2000 /Case
22-1100TS	10ml	Natural	No	No	100 /Bag, 10 Bags/Case	1000 /Case

Filter Tips-Rack Pack



>> Features

- Made in Bioclean room
- Extremely straight low retention tips ensure accurate and precise sample
- Extra-long tips: 10µl with max volume 20µl, 200µl with max volume 300µl, and 1000µl with max volume 1250µl
- Racked filter tips, sterile
- DNase & RNase free, non-pyrogenic

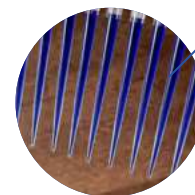
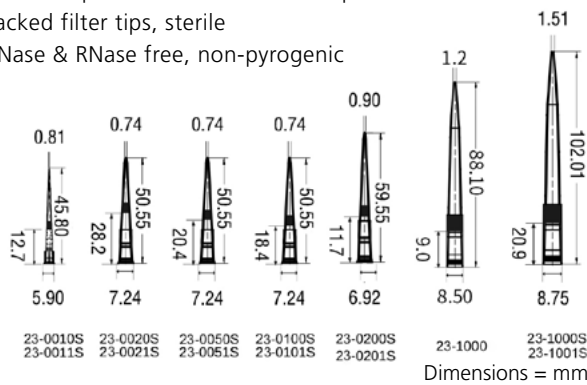

Extremely straight tips

User-friendly label on the tip rack

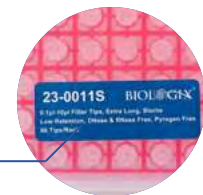

Clear racks enable convenient observation of tips

Cat #	Volume	Color	Sterile	Low Retention	Unit	Total
23-0010S	10µl Extended	Natural	Yes	No	96 tips/Rack, 50 Racks/Case	4800 tips/Case
23-0011S	10µl Extended	Natural	Yes	Yes	96 tips/Rack, 50 Racks/Case	4800 tips/Case
23-0020S	20µl	Yellow	Yes	No	96 tips/Rack, 50 Racks/Case	4800 tips/Case
23-0021S	20µl	Natural	Yes	Yes	96 tips/Rack, 50 Racks/Case	4800 tips/Case
23-0050S	50µl	Natural	Yes	No	96 tips/Rack, 50 Racks/Case	4800 tips/Case
23-0051S	50µl	Natural	Yes	Yes	96 tips/Rack, 50 Racks/Case	4800 tips/Case
23-0100S	100µl	Natural	Yes	No	96 tips/Rack, 50 Racks/Case	4800 tips/Case
23-0101S	100µl	Natural	Yes	Yes	96 tips/Rack, 50 Racks/Case	4800 tips/Case
23-0200S	200µl Extended	Natural	Yes	No	96 tips/Rack, 50 Racks/Case	4800 tips/Case
23-0201S	200µl Extended	Natural	Yes	Yes	96 tips/Rack, 50 Racks/Case	4800 tips/Case
23-0300S	300µl	Natural	Yes	No	96 tips/Rack, 50 Racks/Case	4800 tips/Case
23-0301S	300µl	Natural	Yes	Yes	96 tips/Rack, 50 Racks/Case	4800 tips/Case
23-1000	1000µl	Natural	Yes	No	96/Rack, 6 Rack/Rack, 10 Racks/Case	5760 tips/Case
23-1000S	1000µl Extended	Blue	Yes	No	96 tips/Rack, 50 Racks/Case	4800 tips/Case
23-1001S	1000µl Extended	Natural	Yes	Yes	96 tips/Rack, 50 Racks/Case	4800 tips/Case
23-5000ES	5ml	Natural	Yes	No	24 /Rack, 30 Racks/Case	720 /Case
23-1100ES	10ml	Natural	Yes	No	24 /Rack, 40 Racks/Case	960 /Case
23-5000TS	5ml	Natural	Yes	No	40 /Rack, 40 Racks/Case	1600/Case
23-1100TS	10ml	Natural	Yes	No	24 /Rack, 40 Racks/Case	960 /Case

LTS Pipette Tips

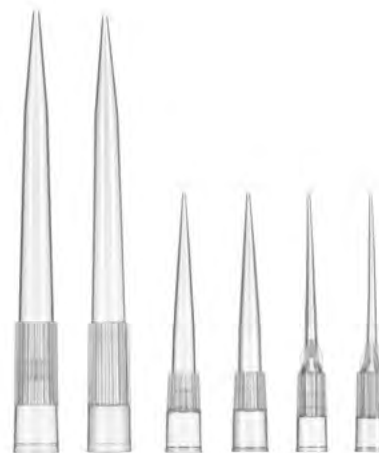

>> Features

- Tips are made of medical grade polypropylene, autoclavable, and filters are made of highly hydrophobic UHMWPE
- 20µl, 200µl, 300µl, 1000µl, and 1200µl tips
- Filters prevent cross-contamination and damage to samples, ensure accurate and precise sample aspiration, and protect the user by preventing sample liquid or vapor from entering the pipette body
- Low-retention tips undergo a coating-free treatment and will not contaminate samples
- User-friendly labels on tip racks enable convenient usage
- DNase & RNase Free, non-pyrogen
- Sterile SAL 10⁻⁶

User-friendly labels on tip racks enable convenient usage



Cat#	Volume	Sterile	Low Retention	Unit
R23-0020	20µl	Yes	No	96 Tips/Rack, 50 Racks/Case
R23-0021	20µl	Yes	Yes	96 Tips/Rack, 50 Racks/Case
R23-0200	200µl	Yes	No	96 Tips/Rack, 50 Racks/Case
R23-0201	200µl	Yes	Yes	96 Tips/Rack, 50 Racks/Case
R23-0300	300µl	Yes	No	96 Tips/Rack, 50 Racks/Case
R23-0301	300µl	Yes	Yes	96 Tips/Rack, 50 Racks/Case
R23-1000	1000µl	Yes	No	96 Tips/Rack, 50 Racks/Case
R23-1001	1000µl	Yes	Yes	96 Tips/Rack, 50 Racks/Case
R23-1200	1200µl	Yes	No	96 Tips/Rack, 50 Racks/Case
R23-1201	1200µl	Yes	Yes	96 Tips/Rack, 50 Racks/Case

Non-filtered tips also available.

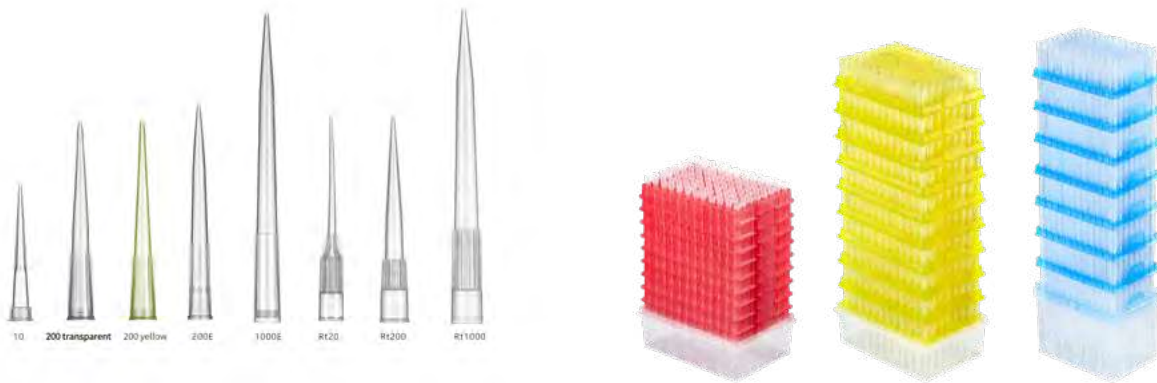

>> Features

- Made from 100% virgin polypropylen, without filters, autoclavable
- Universal Fit Tips: 10µl, 200µl, 200µl extra-long and 1000µl; LTS Tips: 20µl, 200µl, 300µl, 1000µl, and 1200µl
- Low Retention tips are also available
- Refill design saves storage space efficiently
- Made in certified 100,000 cleanroom; RNase & DNase, DNA, pyrogen, and ATP free
- Sterile SAL 10⁻⁶

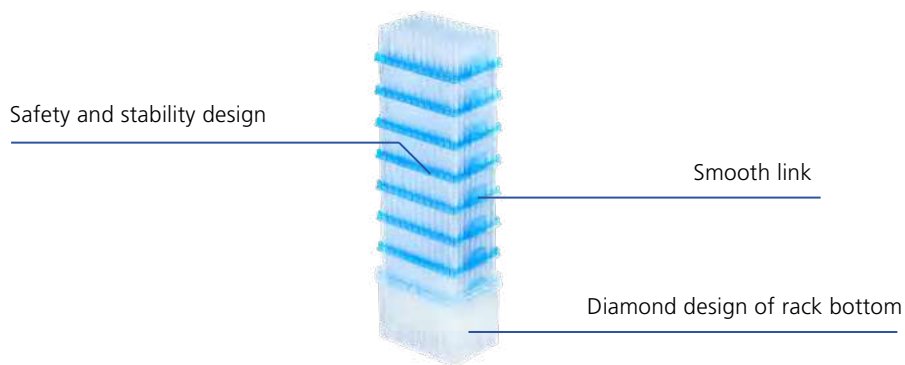

Cat #	Volume	Type	Sterile	Low Retention	Unit
21-R0010S	0.1 to 10µl	Universal Tips	Yes	No	96 Tips/Rack, 10 Racks/Unit, 10 Units/Case
21-R0011S	0.1 to 10µl	Universal Tips	Yes	Yes	96 Tips/Rack, 10 Racks/Unit, 10 Units/Case
21-R0200S	1 to 200µl	Universal Tips	Yes	No	96 Tips/Rack, 12 Racks/Unit, 10 Units/Case
21-R0201S	1 to 200µl	Universal Tips	Yes	Yes	96 Tips/Rack, 12 Racks/Unit, 10 Units/Case
21-R0200ES	1 to 300µl	Universal Tips	Yes	No	96 Tips/Rack, 10 Racks/Unit, 10 Units/Case
21-R0201ES	1 to 300µl	Universal Tips	Yes	Yes	96 Tips/Rack, 10 Racks/Unit, 10 Units/Case
21-R1000S	100 to 1000µl	Universal Tips	Yes	No	96 Tips/Rack, 8 Racks/Unit, 10 Units/Case
21-R1001S	100 to 1000µl	Universal Tips	Yes	Yes	96 Tips/Rack, 8 Racks/Unit, 10 Units/Case
R21-R0020S	20µl	LTS Tips	Yes	No	96 Tips/Rack, 10 Racks/Unit, 10 Units/Case
R21-R0021S	20µl	LTS Tips	Yes	Yes	96 Tips/Rack, 10 Racks/Unit, 10 Units/Case
R21-R0200S	200µl	LTS Tips	Yes	No	96 Tips/Rack, 10 Racks/Unit, 10 Units/Case
R21-R0201S	200µl	LTS Tips	Yes	Yes	96 Tips/Rack, 10 Racks/Unit, 10 Units/Case
R21-R0300S	300µl	LTS Tips	Yes	No	96 Tips/Rack, 8 Racks/Unit, 10 Units/Case
R21-R0301S	300µl	LTS Tips	Yes	Yes	96 Tips/Rack, 8 Racks/Unit, 10 Units/Case
R21-R1000S	1000µl	LTS Tips	Yes	No	96 Tips/Rack, 8 Racks/Unit, 10 Units/Case
R21-R1001S	1000µl	LTS Tips	Yes	Yes	96 Tips/Rack, 8 Racks/Unit, 10 Units/Case
R21-R1200S	1200µl	LTS Tips	Yes	No	96 Tips/Rack, 8 Racks/Unit, 10 Units/Case
R21-R1201S	1200µl	LTS Tips	Yes	Yes	96 Tips/Rack, 8 Racks/Unit, 10 Units/Case

Automation Tips



>> Features

- Made of medical grade polypropylene /black conductive medical grade polypropylene, autoclavable
- Compatible with Beckman, Tecan, Hamilton, and Agilent workstations
- Clear/black conductive tips, filtered/non-filtered tips, sterile/non-sterile tips
low-retention/non low-retention tips available
- DNase & RNase Free, non-pyrogen
- Electron beam sterilization, SAL 10⁻⁶



Cat #	Volume	Matched Workstations	Features	Length mm	Unit
AB23-0020S	20µl	Beckman FX/NX	Clear, filtered, sterile, green racks	Standard (38.20)	96 Tips/Rack, 10 Racks/Pack, 5 Packs/Case
AB23-0050S	50µl	Beckman FX/NX	Clear, filtered, sterile, blue racks	Standard (51.20)	96 Tips/Rack, 10 Racks/Pack, 5 Packs/Case
AB23-0250S	250µl	Beckman FX/NX	Clear, filtered, sterile, purple racks	Standard (51.20)	96 Tips/Rack, 10 Racks/Pack, 5 Packs/Case
AT23-0020S	20µl	Tecan Genesis Freedom/ Freedom Evo	Clear, filtered, sterile	Standard (35.35)	96 Tips/Rack, 24 Racks/Case
AT23-0020CS	20µl	Tecan Genesis Freedom/ Freedom Evo	Conductive, filtered, sterile	Standard (35.35)	96 Tips/Rack, 24 Racks/Case
AT23-0050S	50µl	Tecan Genesis Freedom/ Freedom Evo	Clear, filtered, sterile	Standard (58)	96 Tips/Rack, 24 Racks/Case
AT23-0050CS	50µl	Tecan Genesis Freedom/ Freedom Evo	Conductive, filtered, sterile	Standard (58)	96 Tips/Rack, 24 Racks/Case
AT23-0200S	200µl	Tecan Genesis Freedom/ Freedom Evo	Clear, filtered, sterile	Standard (58.5)	96 Tips/Rack, 24 Racks/Case
AT23-0200CS	200µl	Tecan Genesis Freedom/ Freedom Evo	Conductive, filtered, sterile	Standard (58.5)	96 Tips/Rack, 24 Racks/Case
AT23-1000S	1000µl	Tecan Genesis Freedom/ Freedom Evo	Clear, filtered, sterile	Standard (95.5)	96 Tips/Rack, 16 Racks/Case
AT23-1000CS	1000µl	Tecan Genesis Freedom/ Freedom Evo	Conductive, filtered, sterile	Standard (95.5)	96 Tips/Rack, 16 Racks/Case
AH23-0050S	50µl	Hamilton Star/Starlet/Nimbus	Clear, filtered, sterile	Standard (50.4)	96 Tips/Rack, 24 Racks/Case
AH23-0050CS	50µl	Hamilton Star/Starlet/Nimbus	Conductive, filtered, sterile	Standard (50.4)	96 Tips/Rack, 24 Racks/Case
AH23-0300S	300µl	Hamilton Star/Starlet/Nimbus	Clear, filtered, sterile	Standard (60)	96 Tips/Rack, 24 Racks/Case
AH23-0300CS	300µl	Hamilton Star/Starlet/Nimbus	Conductive, filtered, sterile	Standard (60)	96 Tips/Rack, 24 Racks/Case
AH23-1000S	1000µl	Hamilton Star/Starlet/Nimbus	Clear, filtered, sterile	Standard (95)	96 Tips/Rack, 16 Racks/Case
AH23-1000CS	1000µl	Hamilton Star/Starlet/Nimbus	Conductive, filtered, sterile	Standard (95)	96 Tips/Rack, 16 Racks/Case
AA21-0030S	30µl	Agilent	Clear, sterilized	Standard (26.04)	384 Tips/Rack, 10 Racks/Pack, 5 Packs/Case
AA23-0250S	250µl	Agilent	Clear, filtered, sterilized	Standard (55.50)	96 Tips/Rack, 10 Racks/Pack, 5 Packs/Case

*Please call for more product models

Pipet Tip Compatibility

Pipet Tips

Pipette Brand		Axygen Axyptet (Single channel)						Axygen Axyptet (Multichannel)				Nichiyu/Oxford Benchmate			Biohit Proline (Single channel)				
Model / Range		0.1-2µl	0.5-10µl	2-20µl	5-50µl	10-100µl	20-200µl	1-10µl	5-50µl	20-200µl	50-300µl	0.5-10µl	2-20µl	10-50µl	0.2-10µl	5-100µl	10-250µl	10-500µl	50-1000µl
Volume	Product No.	Universal Fit Filter Tips																	
0.5-10ul	20-0010	✓	✓					✓						✓					
	21-0010	✓	✓					✓						✓					
1-200ul	20-0200			✓	✓	✓	✓		✓	✓	✓		✓	✓		✓	✓		
	21-0200			✓	✓	✓	✓		✓	✓	✓		✓	✓		✓	✓		
100-1000ul	20-1000																	✓	✓
	21-1000																	✓	✓
100-1250ul	20-1250																	✓	✓
	20-1251																	✓	✓
	21-1250																	✓	✓

Pipette Brand		Biohit Proline (Multichannel)			Biohit e-line (Single channel)				Biohit e-line (Multi channel)			Biohit m-line (Single channel)		Biohit m-line (Multichannel)					
Model / Range		0.2-10µl	5-100µl	25-250µl	1-10µl	5-120µl	10-300µl	50-1000µl	0.2-10µl	5-120µl	10-300µl	0.5-10µl	2-20µl	10-100µl	20-200µl	100-1000µl	0.5-10µl	5-100µl	30-300µl
Volume	Product No.	Universal Fit Filter Tips																	
0.5-10ul	20-0010	✓			✓				✓									✓	
	21-0010	✓			✓				✓									✓	
1-200ul	20-0200		✓	✓		✓	✓			✓	✓		✓	✓		✓	✓		✓
	21-0200		✓	✓		✓	✓			✓	✓		✓	✓		✓	✓		✓
100-1000ul	20-1000							✓								✓			
	21-1000							✓								✓			
100-1250ul	20-1250							✓								✓			
	20-1251							✓								✓			
	21-1250							✓								✓			

Pipette Brand		Capp Aero (Multichannel)						BrandTech Transferpette (Single channel)						MatrixImpact/Impact(s/mc)					
Model / Range		0.2-2µl	0.5-10µl	5-50µl	10-100µl	25-200µl	50-300µl	100-1000µl	0.1-1µl	0.5-10µl	2-20µl	5-50µl	10-100µl	20-200µl	25-250µl	100-1000µl	20-200µl	5-100µl	30-300µl
Volume	Product No.	Universal Fit Filter Tips																	
0.5-10ul	20-0010	✓	✓						✓	✓									
	21-0010	✓	✓						✓	✓									
1-200ul	20-0200			✓	✓	✓	✓				✓	✓	✓	✓		✓			
	21-0200			✓	✓	✓	✓				✓	✓	✓	✓		✓			
100-1000ul	20-1000							✓							✓				
	21-1000							✓							✓				
100-1250ul	20-1250							✓							✓				
	20-1251							✓							✓				
	21-1250							✓							✓				✓

Pipette Brand		BrandTech Transferpette (Multichannel)						Rainin EDP3 (Single channel)						Rainin Latch Mode					
Model / Range		0.5-10µl	2-20µl	2.5-25µl	5-50µl	10-100µl	20-200µl	30-300µl	E-MIC-10, 0.5-10µl	E2-25, 2.5-25µl	E2-100, 10-100µl	E2-250, 25-250µl	E2-1000, 100-1000µl	R2, 0.1-2µl	R10, 0.2-10µl	R20, 2-20µl	R100, 10-100µl	R200, 20-200µl	R1000, 100-1000µl
Volume	Product No.	Universal Fit Filter Tips																	
0.5-10ul	20-0010	✓	✓						✓					✓	✓				
	21-0010	✓	✓						✓					✓	✓				

Pipet Tip Compatibility

Pipette Brand		BrandTech Transferpette (Multichaanel)						Rainin EDP3 (Single channel)					Rainin Latch Mode						
Model / Range		0.5-10µl	2-20µl	2.5-25µl	5-50µl	10-100µl	20-200µl	30-300µl	E-MIC-10, 0.5-10µl	E2-25, 2.5-25µl	E2-100, 10-100µl	E2-250, 25-250µl	E2-1000, 100-1000µl	R2, 0.1-2µl	R10, 0.2-10µl	R20, 2-20µl	R100, 10-100µl	R200, 20-200µl	R1000, 100-1000µl
Volume	Product No.	Universal Fit Filter Tips																	
1-200ul	20-0200			✓	✓	✓	✓			✓	✓	✓				✓	✓	✓	
	21-0200			✓	✓	✓	✓			✓	✓	✓				✓	✓	✓	
100-1000ul	20-1000							✓					✓						✓
	21-1000							✓					✓						✓
100-1250ul	20-1250							✓					✓						✓
	20-1251							✓					✓						✓
	21-1250							✓					✓						✓

Pipette Brand		Labnet Labpette (Single chaanel)					Labnet Labpette (Multichaanel)				Labnet Biopette E (Single chaanel)			Labnet Biopette E (Multichaanel)					
Model / Range		0.1-2µl	0.5-10µl	2-20µl	10-100µl	20-200µl	100-1000µl	1-10µl	5-50µl	20-200µl	50-300µl	0.5-10µl	2-20µl	10-200µl	100-1000µl	0.5-10µl	2-20µl	10-200µl	100-1000µl
Volume	Product No.	Universal Fit Filter Tips																	
0.5-10ul	20-0010	✓	✓					✓				✓	✓		✓	✓			
	21-0010	✓	✓					✓				✓	✓		✓	✓			
1-200ul	20-0200			✓	✓	✓			✓	✓	✓			✓				✓	
	21-0200			✓	✓	✓			✓	✓	✓			✓				✓	
100-1000ul	20-1000						✓							✓					✓
	21-1000						✓							✓					✓
100-1250ul	20-1250						✓							✓					✓
	20-1251						✓							✓					✓
	21-1250						✓							✓					✓

Pipette Brand		Eppendorf Electronic				Socorex Calibra/Accura (Single chaanel)						VWR AND VWR Signature(Multichannel)				Rainin EDP3 (Multichannel)				
Model / Range		0.5-10µl	5-100µl	2-200µl	50-1000µl	0.1-2µl	0.2-2µl	0.5-10µl	1-10µl	2-20µl	10-100µl	20-200µl	100-1000µl	1-10µl	5-50µl	20-200µl	50-300µl	EP-M8-10, 0.5-10µl	EP-M8250, 10-250µl	P200-M8, 20-200µl
Volume	Product No.	Universal Fit Filter Tips																		
0.5-10ul	20-0010	✓				✓	✓	✓	✓					✓				✓		
	21-0010	✓				✓	✓	✓	✓					✓				✓		
1-200ul	20-0200		✓	✓					✓	✓	✓			✓	✓	✓			✓	✓
	21-0200		✓	✓					✓	✓	✓			✓	✓	✓			✓	✓
100-1000ul	20-1000				✓							✓								✓
	21-1000				✓							✓								✓
100-1250ul	20-1250				✓							✓								✓
	20-1251				✓							✓								✓
	21-1250				✓							✓								✓

Pipette Brand		VWR AND VWR Signature (Single channel)							Socorex Calibra/Accura (Multichaanel)					EppendorfReference (single channel) (multichannel)					
Model / Range		0.1-2µl	0.5-10µl	2-20µl	5-50µl	10-100µl	20-200µl	50-250µl	100-1000µl	1-10µl	5-50µl	10-100µl	20-200µl	50-200µl	0.1-10µl	2-20µl	10-100µl	20-200µl	100-1000µl
Volume	Product No.	Universal Fit Filter Tips																	
0.5-10ul	20-0010	✓	✓							✓					✓				
	21-0010	✓	✓							✓					✓				
1-200ul	20-0200			✓	✓	✓	✓	✓		✓	✓	✓	✓		✓	✓	✓	✓	✓
	21-0200			✓	✓	✓	✓	✓		✓	✓	✓	✓		✓	✓	✓	✓	✓
100-1000ul	20-1000							✓						✓	✓	✓	✓	✓	✓

Pipet Tip Compatibility

Pipette Brand		VWR AND VWR Signature (Single channel)								Socorex Calibra/Accura (Multichannel)					EppendorfReference (single channel)(multichannel)				
Model / Range		0.1-2µl	0.5-10µl	2-20µl	5-50µl	10-100µl	20-200µl	50-250µl	100-1000µl	1-10µl	5-50µl	10-100µl	20-200µl	50-200µl	0.1-10µl	2-20µl	10-100µl	20-200µl	100-1000µl
Volume	Product No.	Universal Fit Filter Tips																	
100-1000ul	21-1000								✓										✓
	20-1250								✓										✓
100-1250ul	20-1251								✓										✓
	21-1250								✓										✓

Pipette Brand		Eppendorf Research (singlechannel)					Eppendorf Research (multichannel)					Thermo Scientif Finnpiptette (single channel)							
Model / Range		0.1-2.5µl	0.5-10µl	2-20µl	10-100µl	25-200µl	100-1000µl	0.5-10µl	5-100µl	50-100µl	20-300µl	30-300µl	50-1200µl	0.2-10µl	0.5-10µl	5-40µl	40-200µl	100-1000µl	200-1000µl
Volume	Product No.	Universal Fit Filter Tips																	
0.5-10ul	20-0010	✓	✓					✓						✓	✓				
	21-0010	✓	✓					✓						✓	✓				
1-200ul	20-0200				✓	✓			✓	✓	✓	✓				✓	✓		
	21-0200				✓	✓			✓	✓	✓	✓				✓	✓		
100-1000ul	20-1000				✓	✓			✓	✓	✓	✓				✓	✓		
	21-1000				✓	✓			✓	✓	✓	✓				✓	✓		✓
100-1250ul	20-1250						✓					✓						✓	✓
	20-1251						✓											✓	✓
	21-1250						✓											✓	✓

Pipette Brand		Thermo Scientif Finnpiptette (multichannel)		Gilson Pipetma (single channel)					
Model / Range		5-50µl	50-300µl	P2,0.1-2µl	P10, 0.2-10µl	P20, 2-20µl	P100, 10-100µl	P200, 20-200µl	P1000, 100-1000µl
Volume	Product No.	Universal Fit Filter Tips							
0.5-10ul	20-0010			✓	✓				
	21-0010			✓	✓				
1-200ul	20-0200	✓	✓			✓	✓	✓	
	21-0200	✓	✓			✓	✓	✓	
100-1000ul	20-1000	✓	✓			✓	✓	✓	
	21-1000								✓
100-1250ul	20-1250								✓
	20-1251								✓
	21-1250								✓

Filter Tips-Bulk Pack

Pipette Brand		Eppendorf Research Plus						Gilson Pipetman(PG)					Gilson Pipetman(PN)					Gilson Pipetman(PL)							
Model / Range		0.1-2.5µl	0.5-10µl	2-20µl	10-100µl	20-200µl	100-1000µl	P2, 0.2-2µl	P10, 1-10µl	P20, 2-20µl	P100,10-100µl	P200, 20-200µl	P1000, 100-1000µl	P2, 0.2-2µl	P10, 1-10µl	P20, 2-20µl	P100, 10-100µl	P200, 20-200µl	P1000, 100-1000µl	P2, 0.2-2µl	P10, 1-10µl	P20, 2-20µl	P100, 10-100µl	P200, 20-200µl	P1000, 100-1000µl
Volume	Product No.	Universal Fit Filter Tips																							
0.5-10ul	22-0010S	✓	✓					✓	✓					✓	✓					✓	✓				
	22-0011S	✓	✓					✓	✓					✓	✓					✓	✓				
1-20ul	22-0020S			✓	✓	✓			✓							✓						✓			

Pipet Tip Compatibility

Pipette Brand		Eppendorf Research Plus						Gilson Pipetman(PG)					Gilson Pipetman(PN)					Gilson Pipetman(PL)								
Model / Range		0.1-2.5µl	0.5-10µl	2-20µl	10-100µl	20-200µl	120-1000µl	0.2-2µl	1-10µl	2-20µl	10-100µl	20-200µl	100-1000µl	0.2-2µl	1-10µl	2-20µl	10-100µl	20-200µl	100-1000µl	0.2-2µl	1-10µl	2-20µl	10-100µl	20-200µl	100-1000µl	
Volume	Product No.	Universal Fit Filter Tips																								
1-20ul	22-0021S			✓	✓	✓			✓						✓											
1-50ul	22-0050S				✓	✓				✓	✓					✓	✓							✓		
	22-0051S									✓	✓					✓	✓						✓	✓		
1-100ul	22-0100S				✓	✓				✓	✓					✓	✓						✓	✓		
	22-0101S									✓	✓					✓	✓						✓	✓		
1-300ul	22-0200S				✓	✓				✓	✓					✓	✓						✓	✓		
	22-0201S									✓	✓					✓	✓						✓	✓		
100-1000ul	22-1000S						✓						✓							✓					✓	
	22-1001S						✓						✓							✓					✓	

Pipette Brand		Thermo Finnpiquette (F1)										Thermo Finnpiquette (F2)										Thermo Finnpiquette (F3)													
Model / Range		0.2-2µl	1-10µl	1-10µl(µTip)	2-20µl	2-20µl(µTip)	5-50µl	5-50µl(µTip)	10-100µl	20-200µl	30-300µl	100-1000µl	0.2-2µl(µTip)	1-10µl	1-10µl(µTip)	2-20µl	2-20µl(µTip)	5-50µl	5-50µl(µTip)	10-100µl	20-200µl	100-1000µl	0.2-2µl	1-10µl	1-10µl(µTip)	2-20µl	2-20µl(µTip)	5-50µl	5-50µl(µTip)	10-100µl	20-200µl	100-1000µl			
Volume	Product No.	Universal Fit Filter Tips																																	
0.5-10ul	22-0010S	✓	✓											✓										✓	✓										
	22-0011S	✓	✓											✓										✓	✓										
1-20ul	22-0020S				✓																						✓								
	22-0021S				✓																						✓								
1-50ul	22-0050S					✓		✓	✓	✓								✓										✓							
	22-0051S					✓		✓	✓	✓								✓										✓							
1-100ul	22-0100S					✓		✓	✓	✓								✓										✓							
	22-0101S					✓		✓	✓	✓								✓										✓							
1-300ul	22-0200S							✓	✓	✓								✓										✓							
	22-0201S							✓	✓	✓								✓										✓							
100-1000ul	22-1000S										✓													✓											
	22-1001S										✓													✓											

Pipette Brand		BIOHIT PROLINE								BIOHIT PROLINE (Plus)								BRAND									
Model / Range		0.1-2.5µl	0.5-10µl	2-20µl	5-50µl	10-100µl	20-200µl	50-300µl	100-1000µl	0.1-3µl	0.5-10µl	2-20µl	5-50µl	10-100µl	20-200µl	30-300µl	100-1000µl	0.1-1µl	0.1-2.5µl	0.5-10µl	2-20µl	5-50µl	10-100µl	20-200µl	30-300µl	100-1000µl	
Volume	Product No.	Universal Fit Filter Tips																									
0.5-10ul	22-0010S	✓	✓							✓	✓							✓	✓	✓							
	22-0011S	✓	✓							✓	✓							✓	✓	✓							
1-20ul	22-0020S			✓																	✓	✓	✓	✓	✓		
	22-0021S			✓																	✓	✓	✓	✓	✓		
1-50ul	22-0050S				✓	✓	✓	✓				✓	✓	✓	✓						✓	✓	✓	✓	✓		
	22-0051S				✓	✓	✓	✓				✓	✓	✓	✓						✓	✓	✓	✓	✓		

Pipet Tip Compatibility

Pipette Brand		BIOHIT PROLINE							BIOHIT PROLINE (Plus)							BRAND										
Model / Range		0.1-2.5µl	0.5-10µl	2-20µl	5-50µl	10-100µl	20-200µl	50-300µl	100-1000µl	0.1-3µl	0.5-10µl	2-20µl	5-50µl	10-100µl	20-200µl	30-300µl	100-1000µl	0.1-1µl	0.1-2.5µl	0.5-10µl	2-20µl	5-50µl	10-100µl	20-200µl	30-300µl	100-1000µl
Volume	Product No.	Universal Fit Filter Tips																								
1-100ul	22-0100S					✓	✓	✓					✓	✓	✓							✓	✓	✓	✓	
	22-0101S					✓	✓	✓					✓	✓	✓							✓	✓	✓	✓	
1-300ul	22-0200S						✓	✓						✓	✓									✓	✓	
	22-0201S						✓	✓						✓	✓									✓	✓	
100-1000ul	22-1000S								✓								✓									✓
	22-1001S								✓								✓									✓

Filter Tips-Rack Pack

Pipette Brand		BIOHIT PROLINE							BIOHIT PROLINE (Plus)							BRAND										
Model / Range		0.1-2.5µl	0.5-10µl	2-20µl	5-50µl	10-100µl	20-200µl	50-300µl	100-1000µl	0.1-3µl	0.5-10µl	2-20µl	5-50µl	10-100µl	20-200µl	30-300µl	100-1000µl	0.1-1µl	0.1-2.5µl	0.5-10µl	2-20µl	5-50µl	10-100µl	20-200µl	30-300µl	100-1000µl
Volume	Product No.	Universal Fit Filter Tips																								
0.5-10ul	23-0010S	✓	✓							✓	✓							✓	✓	✓						
	23-0011S	✓	✓							✓	✓							✓	✓	✓						
1-20ul	23-0020S			✓																	✓	✓	✓	✓	✓	
	23-0021S			✓																	✓	✓	✓	✓	✓	
1-50ul	23-0050S				✓	✓	✓	✓				✓	✓	✓	✓							✓	✓	✓	✓	✓
	23-0051S				✓	✓	✓	✓				✓	✓	✓	✓							✓	✓	✓	✓	✓
1-100ul	23-0100S					✓	✓	✓					✓	✓	✓								✓	✓	✓	✓
	23-0101S					✓	✓	✓					✓	✓	✓								✓	✓	✓	✓
1-300ul	23-0200S						✓	✓						✓	✓									✓	✓	
	23-0201S						✓	✓						✓	✓									✓	✓	
100-1000ul	23-1000								✓								✓									✓
	23-1000S								✓								✓									✓
	23-1001S								✓								✓									✓

Pipette Brand		Eppendorf Research Plus						Gilson Pipetman(PG)					Gilson Pipetman(PN)					Gilson Pipetman(PL)								
Model / Range		0.1-2.5µl	0.5-10µl	2-20µl	10-100µl	20-200µl	100-1000µl	0.2-2µl	1-10µl	2-20µl	10-100µl	20-200µl	100-1000µl	0.2-2µl	1-10µl	2-20µl	10-100µl	20-200µl	100-1000µl	0.2-2µl	1-10µl	2-20µl	10-100µl	20-200µl	100-1000µl	
Volume	Product No.	Universal Fit Filter Tips																								
0.5-10ul	23-0010S	✓	✓					✓	✓					✓	✓						✓	✓				
	23-0011S	✓	✓					✓	✓					✓	✓						✓	✓				
1-20ul	23-0020S			✓	✓	✓			✓							✓							✓	✓		
	23-0021S			✓	✓	✓			✓							✓							✓	✓		
1-50ul	23-0050S				✓	✓	✓			✓	✓				✓	✓							✓	✓	✓	✓
	23-0051S				✓	✓	✓			✓	✓				✓	✓							✓	✓	✓	✓
1-100ul	23-0100S				✓	✓	✓			✓	✓				✓	✓							✓	✓	✓	✓
	23-0101S				✓	✓	✓			✓	✓				✓	✓							✓	✓	✓	✓
1-200ul	23-0200S				✓	✓	✓			✓	✓				✓	✓							✓	✓	✓	✓
	23-0201S				✓	✓	✓			✓	✓				✓	✓							✓	✓	✓	✓

Pipet Tip Compatibility

Pipette Brand		Eppendorf Research Plus						Gilson Pipetman(PG)					Gilson Pipetman(PN)					Gilson Pipetman(PL)								
Model / Range		0.1-2.5µl	0.5-10µl	2-20µl	10-100µl	20-200µl	120-1000µl	0.2-2µl	1-10µl	2-20µl	10-100µl	20-200µl	100-1000µl	0.2-2µl	1-10µl	2-20µl	10-100µl	20-200µl	100-1000µl	0.2-2µl	1-10µl	2-20µl	10-100µl	20-200µl	100-1000µl	
Volume	Product No.	Universal Fit Filter Tips																								
1-300ul	23-0300S				✓	✓							✓					✓							✓	
	23-0301S				✓	✓							✓					✓							✓	
100-1000ul	23-1000						✓						✓						✓						✓	
	23-1000S						✓						✓						✓						✓	
	23-1001S						✓						✓						✓						✓	

Pipette Brand		Thermo Finnpiquette (F1)									Thermo Finnpiquette (F2)						Thermo Finnpiquette (F3)																	
Model / Range		0.2-2µl	1-10µl	1-10µl(µTip)	2-20µl	2-20µl(µTip)	5-50µl	5-50µl(µTip)	10-100µl	20-200µl	30-300µl	100-1000µl	0.2-2µl(µTip)	1-10µl	1-10µl(µTip)	2-20µl	2-20µl(µTip)	5-50µl	5-50µl(µTip)	10-100µl	20-200µl	100-1000µl	0.2-2µl	1-10µl	1-10µl(µTip)	2-20µl	2-20µl(µTip)	5-50µl	5-50µl(µTip)	10-100µl	20-200µl	100-1000µl		
Volume	Product No.	Universal Fit Filter Tips																																
0.5-10ul	23-0010S	✓	✓											✓										✓	✓									
	23-0011S	✓	✓											✓										✓	✓									
1-20ul	23-0020S				✓											✓											✓							
	23-0021S				✓											✓											✓							
1-50ul	23-0050S					✓		✓	✓	✓						✓			✓										✓		✓	✓		
	23-0051S					✓		✓	✓	✓						✓			✓										✓		✓	✓		
1-100ul	23-0100S					✓		✓	✓	✓						✓			✓										✓		✓	✓		
	23-0101S					✓		✓	✓	✓						✓			✓										✓		✓	✓		
1-200ul	23-0200S							✓	✓	✓						✓			✓										✓		✓	✓		
	23-0201S							✓	✓	✓						✓			✓										✓		✓	✓		
1-300ul	23-0300S							✓	✓	✓						✓			✓										✓		✓	✓		
	23-0301S							✓	✓	✓						✓			✓										✓		✓	✓		
100-1000ul	23-1000										✓													✓	✓									✓
	23-1000S										✓													✓	✓									✓
	23-1001S										✓													✓	✓									✓

LTS Pipette Tips

Pipette Brand		Rainin pipette Lite(XLS)									Rainin pipette Lite(LTS)								
Model / Range		0.1-2µl	0.5-10µl	2-20µl	10-100µl	20-200µl	20-300µl	100-1000µl	100-1200µl	0.1-2µl	0.5-10µl	2-20µl	10-100µl	20-200µl	20-300µl	100-1000µl	100-1200µl		
Volume	Product No.	Universal Fit Filter Tips																	
0.1-20ul	R23-0020	✓	✓	✓						✓	✓	✓							
	R23-0021	✓	✓	✓						✓	✓	✓							
1-200ul	R23-0200				✓	✓						✓	✓						
	R23-0201				✓	✓						✓	✓						
1-300ul	R23-0300				✓	✓	✓					✓	✓	✓					
	R23-0301				✓	✓	✓					✓	✓	✓					
100-1000ul	R23-1000															✓	✓		
	R23-1001															✓	✓		
100-1200ul	R23-1200															✓	✓		
	R23-1201															✓	✓		



>> Features

- Polyethylene pipettes will not shatter or break
- An excellent alternative to Pasteur pipettes and rubber bulbs
- Evenly distributed thickness ensures uniform suction force
- Gamma radiation sterilized option available
- Available wrapped individually (sterile) or in bulk package (non-sterile)
- DNase & RNase free

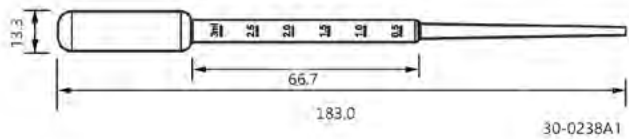
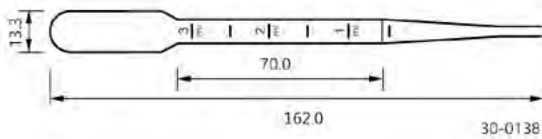
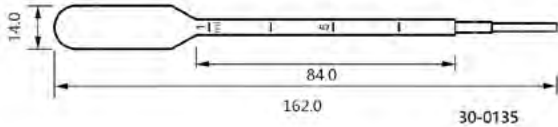
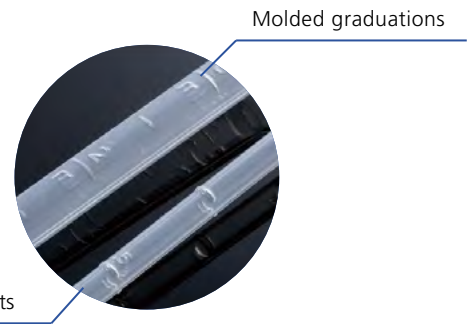

Dimensions = mm

Cat #	Length	Graduated To	Sterile	Package	Unit	Total
30-0135	162.0mm	1ml	No	Bulk	500 /Pack, 4 Packs/Case	2000 /Case
30-0135A1	162.0mm	1ml	Yes	Individually Wrapped	500 /Pack, 4 Packs/Case	2000 /Case
30-0138	162.0mm	3ml	No	Bulk	500 /Pack, 4 Packs/Case	2000 /Case
30-0138A1	162.0mm	3ml	Yes	Individually Wrapped	500 /Pack, 4 Packs/Case	2000 /Case
30-0238A1	183.0mm	3ml	Yes	Individually Wrapped	500 /Pack, 4 Packs/Case	2000 /Case

Solution Basins



>> Features

- Made of PVC, polystyrene (PS), or strong polypropylene (PP)
- PVC basins have transparent walls to permit easy viewing of contents
- Polypropylene basins are chemically resistant to alcohols and mild organic solvents
- PS one-channel basins are available in three sizes: 25ml, 55ml, and 100ml; 25ml and 55ml basins have a V-shaped bottom design
- PVC one-channel basins have a capacity of 55ml and a V-shaped bottom design
- PP 12-channel basins are double sided: autoclavable, the 12-channel side has a capacity of 5ml per channel; the other side (single-channel) has a capacity of 50ml
- PP 12-channel basins are available in assorted colors: clear, blue, green, pink, and yellow
- PS basins are individually packaged (sterile); PVC and PP basins are bulk packaged (non-sterile)

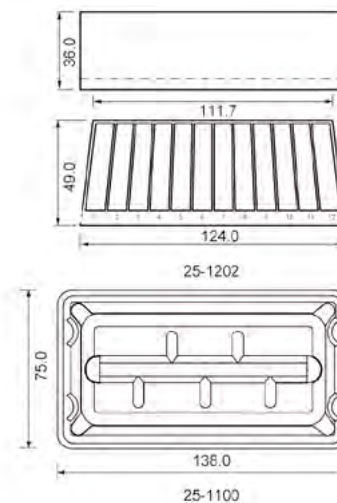
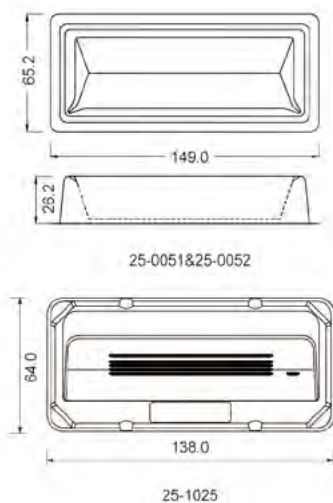

Dimensions = mm

Cat #	Volume	Material	Color	Sterile	Package	Unit	Total
25-1025	25ml	PS	White	Yes	Individually Wrapped	1 /Bag, 100 Bags/Case	100 /Case
25-1202	50ml	PP	Assorted Colors	No	Bulk	25 /Bag, 4 Bags/Case	100 /Case
25-0052	55ml	PVC	Clear	No	Bulk	100 /Bag, 8 Bags/Case	800 /Case
25-0051	55ml	PS	White	Yes	Individually Wrapped	1 /Bag, 100 Bags/Case	100 /Case
25-1100	100ml	PS	White	Yes	Individually Wrapped	1 /Bag, 50 Bags/Case	50 /Case



>> Features

- Made of strong, medical grade polypropylene, autoclavable
- Tri-corner design provides three dripless pouring spouts
- Six different sizes meet different needs

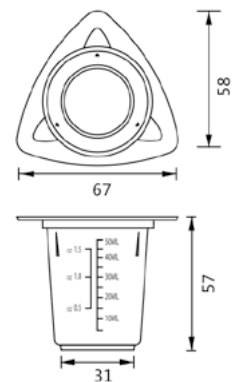
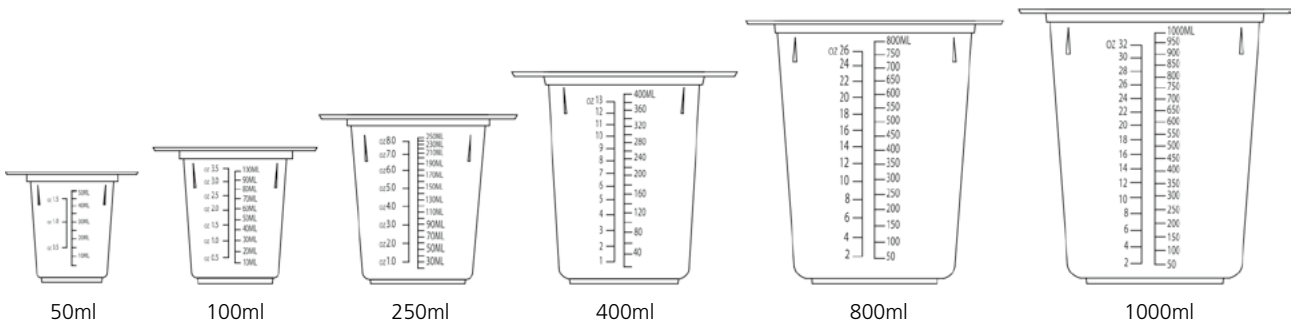

Cat #	Volume	Sterile	Unit	Total
93-0050	50ml	No	25 Pieces/Sleeve, 4 Sleeves/Case	100 /Case
93-0100	100ml	No	25 Pieces/Sleeve, 4 Sleeves/Case	100 /Case
93-0250	250ml	No	25 Pieces/Sleeve, 4 Sleeves/Case	100 /Case
93-0400	400ml	No	25 Pieces/Sleeve, 4 Sleeves/Case	100 /Case
93-0800	800ml	No	25 Pieces/Sleeve, 4 Sleeves/Case	100 /Case
93-1000	1,000ml	No	25 Pieces/Sleeve, 4 Sleeves/Case	100 /Case

Dimensions = mm

Reagent Bottles-Wide Mouth



>> Features

- Made of durable medical grade polypropylene or high-density polyethylene
- Uniform wall thickness and strength, impact-resistant, great chemical resistance to most acid, alkali, and alcohol
- Polypropylene bottles are autoclavable
- Wide-mouth design enables the superior sealing performance, and the convenience for filling liquid
- Lineless caps provide the ultimate in leakproof protection without the use of liner that can wrinkle, cause leaks, or contaminate your reagents
- Amber/brown bottles reduce UV light transmissions to protect light-sensitive liquids; Clear/natural bottles are convenient to observe inner items
- Various volumes are available: 8ml, 15ml, 30ml, 60ml, 125ml, 250ml, 500ml, and 1000ml
- DNase & RNase free, non-pyrogenic
- Sterile bottles also available
- Bottles and caps are packed separately

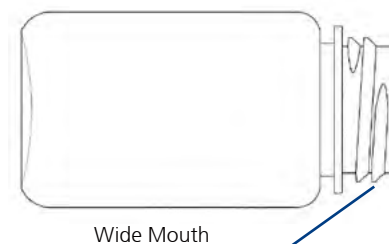

Cat #	Color	Cat #	Color	Volume	Material	Sterile	Unit
04-0008U	Clear	04-1008U	Amber	8ml	PP	No	100 /Bag, 10 Bags/Case
04-0015U	Clear	04-1015U	Amber	15ml	PP	No	100 /Bag, 10 Bags/Case
04-0030U	Clear	04-1030U	Amber	30ml	PP	No	100 /Bag, 10 Bags/Case
04-0060U	Clear	04-1060U	Amber	60ml	PP	No	50 /Bag, 10 Bags/Case
04-0125U	Clear	04-1125U	Amber	125ml	PP	No	25 /Bag, 10 Bags/Case
04-0250U	Clear	04-1250U	Amber	250ml	PP	No	20 /Bag, 10 Bags/Case
04-0500U	Clear	04-1500U	Amber	500ml	PP	No	10 /Bag, 10 Bags/Case
04-0100U	Clear	04-1100U	Amber	1000ml	PP	No	5 /Bag, 10 Bags/Case
04-2008	Natural	04-3008	Brown	8ml	Bottles: HDPE, caps: PP	No	1000 /Case
04-2015	Natural	04-3015	Brown	15ml	Bottles: HDPE, caps: PP	No	1000 /Case
04-2030	Natural	04-3030	Brown	30ml	Bottles: HDPE, caps: PP	No	400 /Case
04-2060	Natural	04-3060	Brown	60ml	Bottles: HDPE, caps: PP	No	650 /Case
04-2125	Natural	04-3125	Brown	125ml	Bottles: HDPE, caps: PP	No	350 /Case
04-2250	Natural	04-3250	Brown	250ml	Bottles: HDPE, caps: PP	No	200 /Case
04-2500	Natural	04-3500	Brown	500ml	Bottles: HDPE, caps: PP	No	100 /Case
04-2100	Natural	04-3100	Brown	1000ml	Bottles: HDPE, caps: PP	No	50 /Case

Reagent Bottles-Narrow Mouth



>> Features

- Made of durable medical grade polypropylene or high-density polyethylene, autoclavable
- Uniform wall thickness and strength, impact-resistant, great chemical resistance to most acid, alkali, and alcohol
- Amber/brown bottles reduce UV light transmissions to protect light-sensitive liquids; Clear/natural bottles are convenient to observe inner items
- Polypropylene bottles are autoclavable
- Various volumes are available: 4ml, 8ml, 15ml, 30ml, 60ml, 125ml, 250ml, 500ml, and 1000ml
- Passed the multi-batch cross-sealing performance test (-90KPA, >5mins), no liquid leakage
- DNase & RNase, foreign DNA free, non-pyrogenic
- Sterile bottles also available
- Bottles and caps are packed separately

Cat #	Color	Cat#	Color	Volume	Material	Sterile	Unit
04-N0004U	Clear	04-N1004U	Amber	4ml	PP	No	200/Bag, 10 Bags/Case
04-N0008U	Clear	04-N1008U	Amber	8ml	PP	No	100/Bag, 10 Bags/Case
04-N0015U	Clear	04-N1015U	Amber	15ml	PP	No	100/Bag, 10 Bags/Case
04-N0030U	Clear	04-N1030U	Amber	30ml	PP	No	100/Bag, 10 Bags/Case
04-N0060U	Clear	04-N1060U	Amber	60ml	PP	No	50/Bag, 10 Bags/Case
04-N0125U	Clear	04-N1125U	Amber	125ml	PP	No	25/Bag, 10 Bags/Case
04-N0250U	Clear	04-N1250U	Amber	250ml	PP	No	20/Bag, 10 Bags/Case
04-N0500U	Clear	04-N1500U	Amber	500ml	PP	No	10/Bag, 10 Bags/Case
04-N0100U	Clear	04-N1100U	Amber	1000ml	PP	No	5/Bag, 10 Bags/Case
04-N2004U	Natural	04-N3004U	Amber	4ml	HDPE	No	200/Bag, 10 Bags/Case
04-N2008U	Natural	04-N3008U	Amber	8ml	HDPE	No	100/Bag, 10 Bags/Case
04-N2015U	Natural	04-N3015U	Amber	15ml	HDPE	No	100/Bag, 10 Bags/Case
04-N2030U	Natural	04-N3030U	Amber	30ml	HDPE	No	100/Bag, 10 Bags/Case
04-N2060U	Natural	04-N3060U	Amber	60ml	HDPE	No	50/Bag, 10 Bags/Case
04-N2125U	Natural	04-N3125U	Amber	125ml	HDPE	No	25/Bag, 10 Bags/Case
04-N2250U	Natural	04-N3250U	Amber	250ml	HDPE	No	20/Bag, 10 Bags/Case
04-N2500U	Natural	04-N3500U	Amber	500ml	HDPE	No	10/Bag, 10 Bags/Case
04-N2100U	Natural	04-N3100U	Amber	1000ml	HDPE	No	5/Bag, 10 Bags/Case

Test Tubes



PS



PP

>> Features

- Tubes: made of medical grade polystyrene or polypropylene
- Caps: made of medical grade polyethylene
- Tubes are available in two sizes: 12 × 75mm and 13 × 100mm

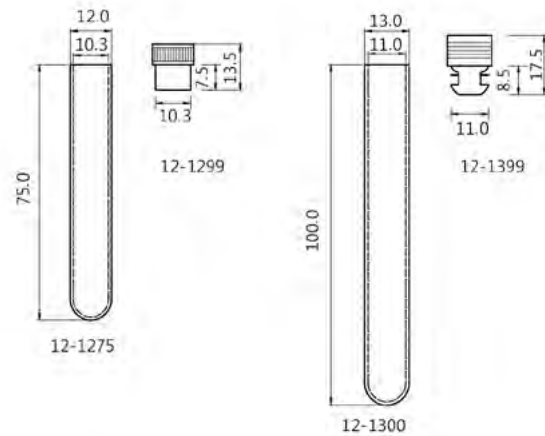

Dimensions = mm

Cat #	Description	Size(mm)	Material	Color	Volume	Sterile	Unit	Total
12-1275	Tube	12x75	PS	Clear	5ml	No	500 /Bag, 4 Bags/Case	2000 /Case
12-2275	Tube	12x75	PP	Clear	5ml	No	500 /Bag, 4 Bags/Case	2000 /Case
12-1300	Tube	13x100	PS	Clear	8ml	No	250 /Bag, 8 Bags/Case	2000 /Case
12-1299	Cap	12x13.5	PE	Blue	-	No	1,000 /Bag, 2 Bags/Case	2000 /Case
12-1399	Cap	13x17.5	PE	Red	-	No	1,000 /Bag, 2 Bags/Case	2000 /Case

Slide Storage Boxes

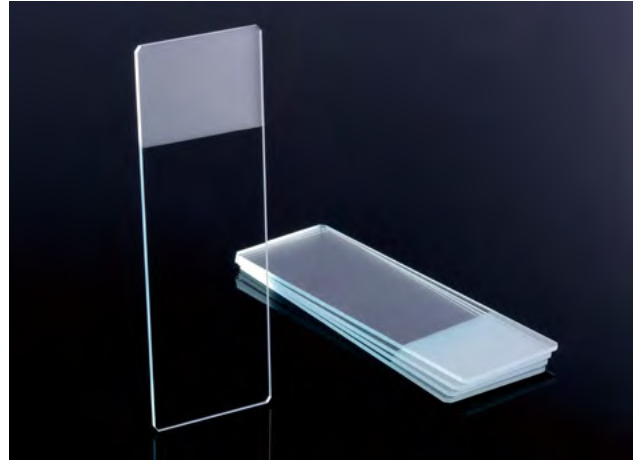

>> Features

Microscope Slides

- Made of high quality, highly transparent glass
- Slide surface highly polished
Ground edges prevent chipping and personal injury
- Slides with frosted area are convenient for labeling and storage
Slides without frosted area have a larger usable surface area

Slide Storage Boxes

- Made of strong ABS material
- Available in 25-place or 100-place sizes
- Traditional cork or foam lining available
- 5 assorted colors available: red, yellow, green, blue, and white
- Store 25mm x 75mm microscope slides
- Each slot is numbered to correspond to the slide inventory sheet inside the lid
- 100-place slide boxes are secured with a rust-resistant clasp and hinge pin

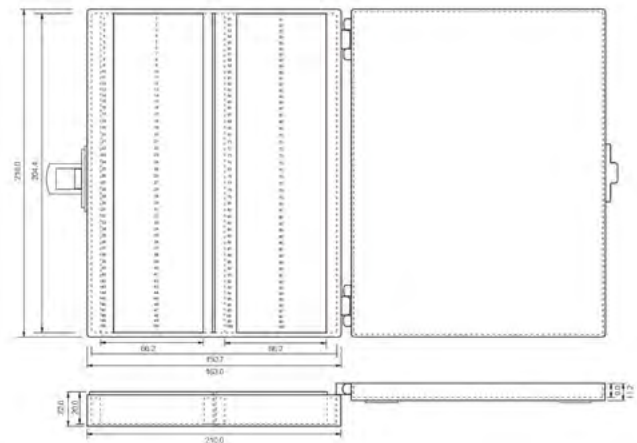

41-5100

Dimensions = mm

Microscope Slides

Cat #	Material	Type	Size (mm)	Sterile	Unit	Total
7101	Clear Glass	Plain Slides	25.4 x 76.2	No	72 /Pack, 50 Packs/Case	3600 /Case
7105	Clear Glass	Single Frosted End	25.4 x 76.2	No	72 /Pack, 50 Packs/Case	3600 /Case

Slide Storage Boxes

Cat #	Place	Lining	Color	Sterile	Unit	Total
41-5025	25-place	Foam	Assorted	No	5 /Bag, 4 Bags/Case	20 /Case
41-6025	25-place	Cork	Assorted	No	5 /Bag, 4 Bags/Case	20 /Case
41-5100	100-place	Foam	Assorted	No	5 /Bag, 6 Bags/Case	30 /Case
41-6100	100-place	Cork	Assorted	No	5 /Bag, 6 Bags/Case	30 /Case

Deep Well Plates



Can be sealed with sealing film or silicone covers

>> Features

- Made of medical grade polypropylene, autoclavable
- Chemically resistant to alcohols and mild organic solvents
- 0.5ml, 1.0ml, 1.6ml, 2.2ml and 10ml volumes available
- Square and round wells, V and U bottom available
- DNase & RNase free, pyrogen free
- Can be sealed with sealing films or silicone sealing mats
- Confirms with SBS standards for automation
- Compatible with automated nucleic acid extraction equipment
- Sterilized, individual wrapped, and with lid type optional

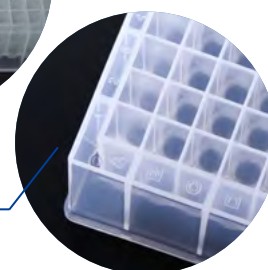

Molded alphanumeric labeling

* Sterilized, individual wrapped, and with lid type optional.

Cat #	Sterile	Cat #	Sterile	Volume	Description	Cap	Unit
02-8005	No	02-8105	Yes	0.5ml	Square 96 wells, V bottom, KingFisher Flex system	No	10 /Pack, 100 /Case
02-2010-50	No	02-2110	Yes	1.0ml	Round 96 wells, U bottom,	No	10 /Pack, 50 /Case
02-1016	No	02-1116	Yes	1.6ml	Square 96 wells, U bottom	No	24 /Pack, 96 /Case
02-1022	No	02-1122	Yes	2.2ml	Square 96 wells, U bottom	No	24 /Pack, 96 /Case
02-6022	No	02-6122	Yes	2.2ml	Square 96 wells, U bottom, profile concave	No	24 /Pack, 96 /Case
02-7022	No	02-7122	Yes	2.2ml	Square 96 wells, V bottom, KingFisher Flex system	No	10 /Pack, 50 /Case
02-9010	No	02-9110	Yes	10ml	Square 24 wells, V bottom, KingFisher Flex system	No	10 /Pack, 50 /Case
02-0096	No	/	/	/	96-well magnet set	/	2 /Pack, 50 /Case
02-0008	No	/	/	/	8-strip magnet set	/	2 /Pack, 100 /Case
02-1096	No	/	/	/	96 square silicone sealing mats, for 96 square deep well plates	/	10 /Pack, 50 /Case
02-1196	No	/	/	/	96 square silicone sealing mats, can be punctured, for 96 square deep well plates	/	10 /Pack, 50 /Case
02-2196	No	/	/	/	96 round silicone sealing mats, can be punctured, for 1.0ml plates	/	10 /Pack, 50 /Case
02-2296	No	/	/	/	96 round silicone sealing mats, can be punctured, for 2.0ml plates	/	10 /Pack, 50 /Case
02-3024	No	/	/	/	24 square silicone sealing mats, for 24 square deep well plates 10ml	/	10 /Pack, 50 /Case
02-000C	/	/	/	/	Cap fits for universal deep well plate, PS	No	10 /Bag, 20 /Pack, 200 /Case
02-000CS	/	/	/	/	Cap fits for universal deep well plate, PS	Yes	10 /Bag, 20 /Pack, 200 /Case

*Please call for more product models

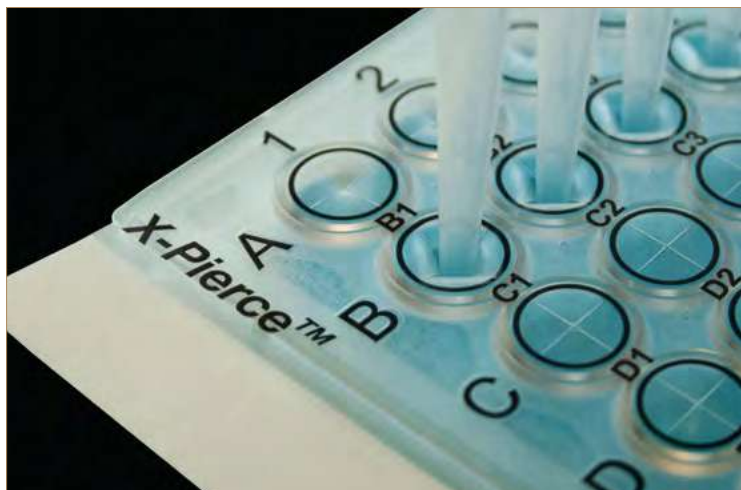

>> Features

- Made of High quality polypropylene, transparent polyester, hard polyester, impermeable aluminum foil, vinyl
- Well with not only PCR, qPCR, ELISA, inoculation and fluorescence experiment but also general and high throughput operation
- Applied to ELISA, inoculation, sample storage and microorganism cultivation sterile/ non-sterile
- Multiple temperature ranges are available, -80°C , -70°C , -40°C , -20°C , +80°C , 90°C , +100°C , +120°C
- Colored sealers with five options are available, green/purple/orange/red/blue
- Film-sealing paddle and plate roller are optional, call for details

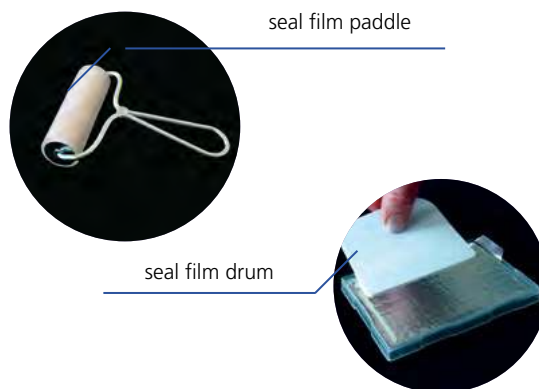

Cat#	Material	Temperature range	Application	Sterile	Unit	Total
61-0010	Polypropylene	-40°C ~ +120°C	ELISA, inoculation	No	100 Pieces/Box	100 /Case
61-0020	Impermeable aluminum foil	-80°C ~+120°C	PCR, cold storage of sample	No	100 Pieces/Box	100 /Case
61-0040	Hard polyester	-40°C ~ +120°C	PCR, qPCR and sample storage	No	100 Pieces/Box	100 /Case
61-0041	Hard polyester	-40°C ~+120°C	PCR, qPCR and sample storage	No	100 pieces/Box	100 /Case
61-0051	Thick porous hydrophobic rayon	-20°C ~+80°C	biological culture	Yes	50 Pieces/Box	50 /Case
61-0060	Thick vinyl	-40°C ~ +90°C	automatic sampling	No	100 Pieces/Box	100 /Case
61-0080	DMSO resistant sealing foil	-80°C ~+120°C	PCR, photosensitive test and mechanical operation	No	100 Pieces/Box	100 /Case
61-0120	Hard polyester	-40°C ~ +120°C	ELISA, inoculation	Yes	2 Rolls/Box, 100 Pieces/Roll, equip with dispenser	200 /Case
61-0152	Thick porous hydrophobic rayon	-20°C ~+80°C	biological culture	Yes	2 Rolls/Box, 50 Pieces/Roll, equip with dispenser	100 /Case
61-0210	Polyolefin	-70°C ~ +100°C	qPCR, sample storage and protein crystallization	No	100 Pieces/Box	100 /Case
61-0303	Transparent polyester	-40°C ~+120°C	PCR, qPCR and sample storage	No	400 Pieces/Box	400 /Case
61-0304	Aluminum foil	-80°C ~ +120°C	PCR, sample storage photosensitive test, automatic operation	No	300 Strip/Box	300 /Case

*Please call for more product models

PCR Tubes



>> Features

- Made of high quality medical grade polypropylene, autoclavable
- Ultra thin-wall tubes provide faster heating and cooling
- High degree of transparency allows for easy observation of samples
- Flat caps are ideal for Real-Time PCR (qPCR)
- Unique cap design prevents opening during cycling and incubation stages
- DNase, RNase, and endotoxin free

Specifications

- Fits most standard thermocyclers
- Can withstand centrifugation of up to 6,000 RCF

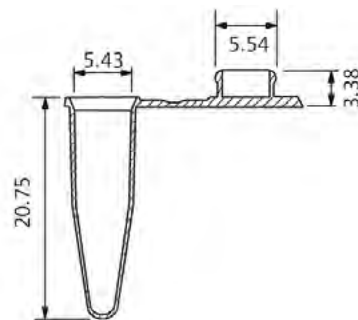

Flat Cap

Dimensions = mm

Cat #	Volume	Color	Cap	Sterile	Unit	Total
60-0082	0.2ml	Clear	Flat-top	No	1,000 /Bag/Pack, 10 Packs/Case	10000 /Case
60-0182*	0.2ml	Pink	Flat-top	No	1,000 /Bag/Pack, 10 Packs/Case	10000 /Case
60-0282*	0.2ml	Green	Flat-top	No	1,000 /Bag/Pack, 10 Packs/Case	10000 /Case
60-0382*	0.2ml	Blue	Flat-top	No	1,000 /Bag/Pack, 10 Packs/Case	10000 /Case
60-0482*	0.2ml	Yellow	Flat-top	No	1,000 /Bag/Pack, 10 Packs/Case	10000 /Case

* Call for details.

* Please contact Biologix for the compatibility of PCR consumables..



>> Features

- Made of high quality medical grade polypropylene, autoclavable
- Ultra thin-wall tubes provide faster heating and cooling
- High degree of transparency allows for easy observation of samples
- Available with domed caps or flat caps
- Domed caps ensure efficient heat transfer
- Flat caps are ideal for Real-Time PCR (qPCR)
- Unique cap design prevents opening during cycling and incubation stages
- DNase, RNase, and endotoxin free

Specifications

- Fits most standard thermocyclers
- Can withstand centrifugation of up to 6,000 RCF
- Packaged in resealable bags



Dome-shaped Caps

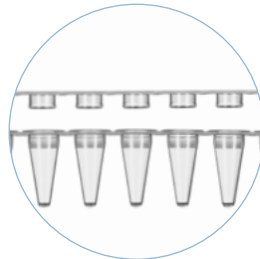

Clear Caps



Flat Caps

Cat#	Volume	Color	Cap Type	Sterile	Unit
60-1088	0.1ml	Clear(qPCR)	Flat	No	125 Tubes+125 Caps/Pack, 10 Packs/Case; 1250 sets/Case
60-1088W	0.1ml	White(qPCR)	Flat	No	125 Tubes+125 Caps/Pack, 10 Packs/Case; 1250 sets/Case
60-0088	0.2ml	Clear	Flat	No	125 Tubes+125 Caps/Pack, 10 Packs/Case; 1250 sets/Case
60-0188*	0.2ml	Pink	Flat	No	125 Tubes+125 Caps/Pack, 10 Packs/Case; 1250 sets/Case
60-0288*	0.2ml	Green	Flat	No	125 Tubes+125 Caps/Pack, 10 Packs/Case; 1250 sets/Case
60-0388*	0.2ml	Blue	Flat	No	125 Tubes+125 Caps/Pack, 10 Packs/Case; 1250 sets/Case
60-0488*	0.2ml	Yellow	Flat	No	125 Tubes+125 Caps/Pack, 10 Packs/Case; 1250 sets/Case
60-0008	0.2ml	Clear	Domed	No	125 Tubes+125 Caps/Pack, 10 Packs/Case; 1250 sets/Case
60-0108*	0.2ml	Pink	Domed	No	125 Tubes+125 Caps/Pack, 10 Packs/Case; 1250 sets/Case
60-0208*	0.2ml	Green	Domed	No	125 Tubes+125 Caps/Pack, 10 Packs/Case; 1250 sets/Case
60-0308*	0.2ml	Blue	Domed	No	125 Tubes+125 Caps/Pack, 10 Packs/Case; 1250 sets/Case
60-0408*	0.2ml	Yellow	Domed	No	125 Tubes+125 Caps/Pack, 10 Packs/Case; 1250 sets/Case

* Call for details.

* Please contact Biologix for the compatibility of PCR consumables..

PCR Plates

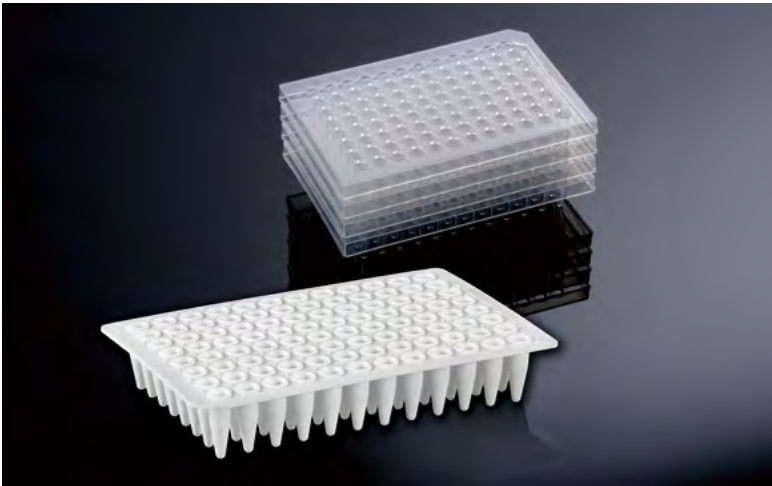

>> Features

- Made of high quality medical grade polypropylene, autoclavable
- Ultra-thin tube walls with uniform thickness for accelerated heat transfer shorter cycle times, and more consistent results
- Alphanumeric well labeling for convenient identification
- DNase, RNase, and endotoxin free

Specifications

- Fits most standard thermocyclers
- Can withstand centrifugation of up to 6,000 RCF



Half-skirted plates are easy to insert and remove



Non-skirted design is more adaptable



Cat #	Volume (per well)	Well	Skirt	Color	Sterile	Unit	Total
60-1016	0.1ml	96-well	Non-skirted	Clear	No	10 Plates/Pack, 10 Packs/Case	100 Plates/Case
60-0016	0.2ml	96-well	Non-skirted	Clear	No	10 Plates/Pack, 10 Packs/Case	100 Plates/Case
60-1016W	0.1ml	96-well	Non-skirted	White	No	10 Plates/Pack, 10 Packs/Case	100 Plates/Case
60-0016W	0.2ml	96-well	Non-skirted	White	No	10 Plates/Pack, 10 Packs/Case	100 Plates/Case
60-0056	0.2ml	96-well	Half-Skirted	Clear	No	5 /Bag, 5 Bags /Pack, 4 Packs/Case	100 Plates/Case
60-0156*	0.2ml	96-well	Half-Skirted	Pink	No	5 /Bag, 5 Bags /Pack, 4 Packs/Case	100 Plates/Case
60-0256*	0.2ml	96-well	Half-Skirted	Green	No	5 /Bag, 5 Bags /Pack, 4 Packs/Case	100 Plates/Case
60-0356*	0.2ml	96-well	Half-Skirted	Blue	No	5 /Bag, 5 Bags /Pack, 4 Packs/Case	100 Plates/Case
60-0456*	0.2ml	96-well	Half-Skirted	Yellow	No	5 /Bag, 5 Bags /Pack, 4 Packs/Case	100 Plates/Case

* Call for details.

* Please contact Biologix for the compatibility of PCR consumables..

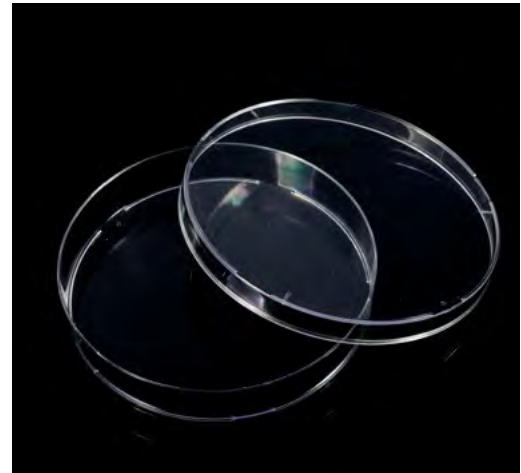

>> Features

- Made of medical grade polystyrene
- Highly transparent for microscopic analysis
- Three sizes available: 60mm, 90mm or 150mm in diameter
- 66-1701 fit automatic systems
- Vented lid for better gas exchange
- Dishes are stackable
- EO Sterile

Vents for gas exchange

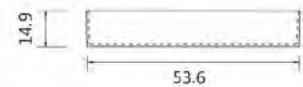
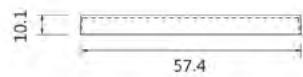
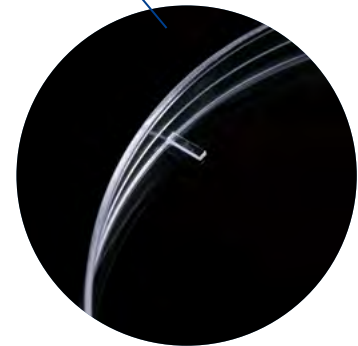

66-1560

66-1501

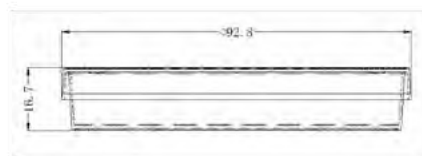
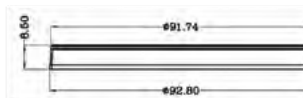

66-1701

Dimensions = mm

Cat #	Size (mm)	Color	Sterile	Unit	Total
66-1560	60x15	Clear	Yes	10 /Bag, 50 Bags/Case	500 /Case
66-1501	90x15	Clear	Yes	10 /Bag, 50 Bags/Case	500 /Case
66-1701	90x17	Clear	Yes	10 /Bag, 50 Bags/Case	500 /Case
66-1515	150x15	Clear	Yes	10 /Bag, 20 Bags/Case	200 /Case

Inoculating Loops & Needles



>> Features

- Made of medical grade polystyrene
- Loops available in 1 μ L and 10 μ L sizes
- The opposite end of each loop can be used as a needle
- Needles are suitable for removal of single-colony specimens
- Gamma radiation sterilized, non-pyrogenic
- Packaged in resealable bags

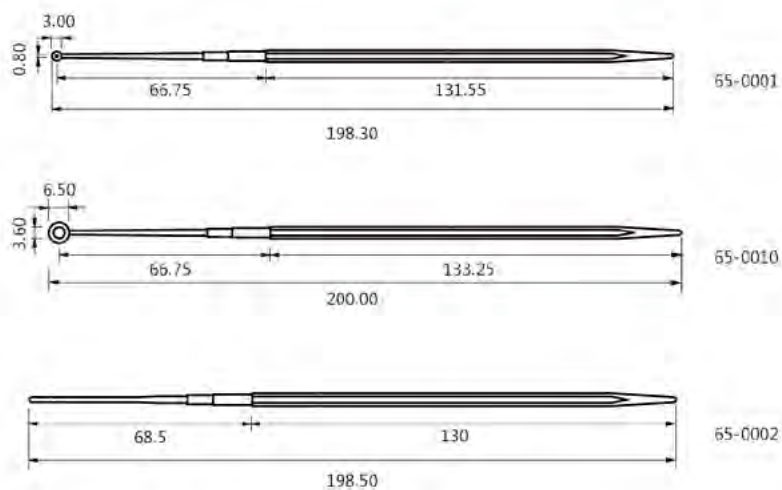

Can be used as needles



Dimensions = mm

Cat #	Size	Description	Color	Sterile	Unit	Total
65-0001	1 μ L	Loops	Blue	Yes	25 /Bag, 40 Bags/Case	1000 /Case
65-0010	10 μ L	Loops	Orange	Yes	25 /Bag, 40 Bags/Case	1000 /Case
65-0002	-	Needles	Yellow	Yes	25 /Bag, 40 Bags/Case	1000 /Case

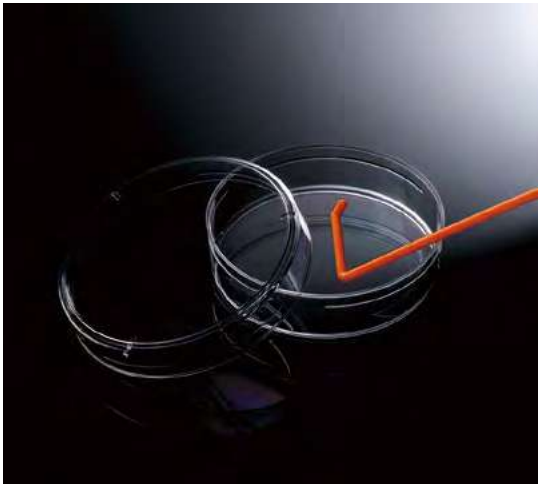
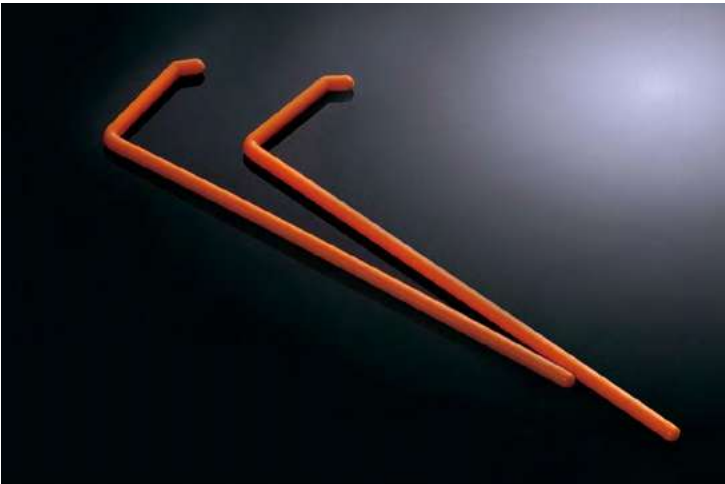

>> Features

- Made of medical grade polystyrene
- Smooth surface quality and angled end reduce the risk of damaging the culture medium
- L-shape allows application on the entire Culture Dish or plate surface
- Two package options: individually wrapped (sterile), or 10 per bag (sterile, resealable)
- Gamma radiation sterilized
- DNase & RNase free, Non-pyrogenic



Individually plastic packaging



Zip-seal packaging

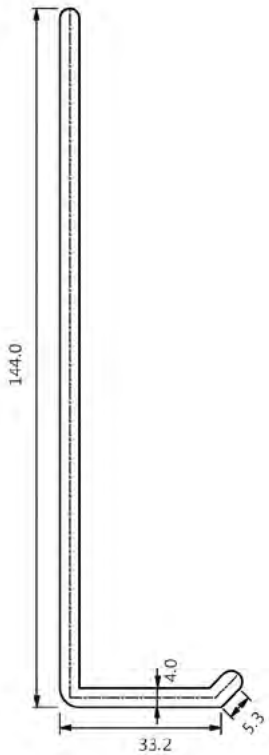

Dimensions = mm

Cat #	Color	Sterile	Unit	Total
65-1001	Orange	Yes	1 /Bag, 500 Bags/Case	500 /Case
65-1010	Orange	Yes	10 /Bag, 50 Bags/Case	500 /Case

Drosophila Vials

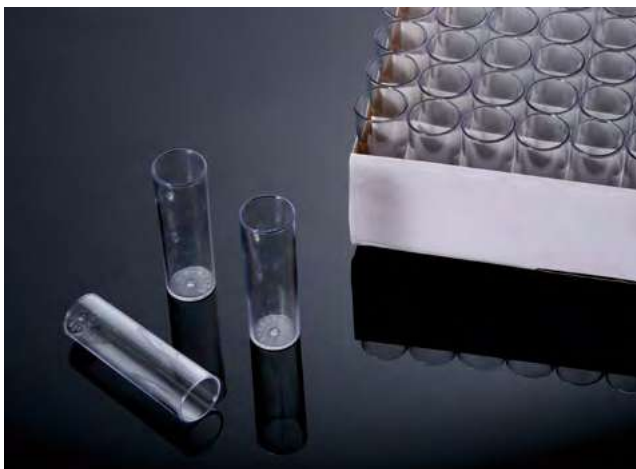

>> Features

- Material: polypropylene, polystyrene, and K-Resin are available
Polypropylene: flexible, corrosion resistant, and fully autoclavable(121°C, 15psi, 15min)
Polystyrene: high transparency and lightweight, easy to observe and store, cost-effective
K-Resin: high transparency, good toughness
- Narrow and wide vials are available
- Safe and cost-effective substitute to glass vials
- Both narrow and wide vials are available in bulk or tray packaging
- Tray packs are great for quick, effortless filling of vials

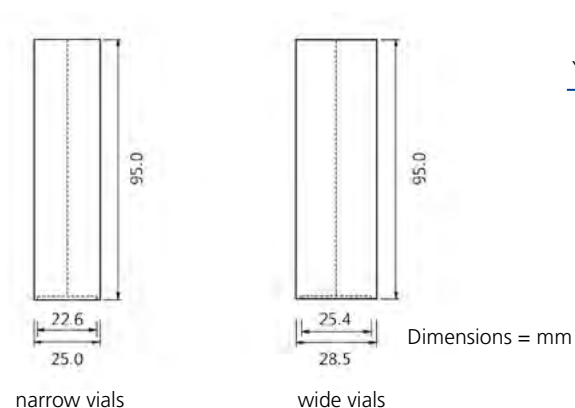

Your can put your logo here



Cat #	Product	Material	Size (mm)	Package	Unit	Total
51-0500	Narrow Vials	PS	25 x 95	Bulk	25/Bag, 20 Bags/Case	500
51-0510	Narrow Vials	PP	25 x 95	Bulk	25/Bag, 20 Bags/Case	500
51-0520	Narrow Vials	K-Resin	25 x 95	Bulk	25/Bag, 20 Bags/Case	500
51-0800	Wide Vials	PS	28.5 x 95	Bulk	25/Bag, 20 Bags/Case	500
51-0810	Wide Vials	PP	28.5 x 95	Bulk	25/Bag, 20 Bags/Case	500
51-0820	Wide Vials	K-Resin	28.5 x 95	Bulk	25/Bag, 20 Bags/Case	500
51-0501	Narrow Vials Combo	PS	25 x 95	Tray	100/Tray, 5 Trays/Case	500
51-0511	Narrow Vials Combo	PP	25 x 95	Tray	100/Tray, 5 Trays/Case	500
51-0521	Narrow Vials Combo	K-Resin	25 x 95	Tray	100/Tray, 5 Trays/Case	500
51-0801	Wide Vials Combo	PS	28.5 x 95	Tray	100/Tray, 5 Trays/Case	500
51-0811	Wide Vials Combo	pp	28.5 x 95	Tray	100/Tray, 5 Trays/Case	500
51-0821	Wide Vials Combo	K-Resin	28.5 x 95	Tray	100/Tray, 5 Trays/Case	500



>> Features

- Material: polypropylene and polyethylene are available
Polypropylene: corrosion resistant and fully autoclavable(121°C, 15psi, 15min)
Polyethylene: stable performance, and not easily damaged
- 6oz square bottom and 8oz round bottom are available
- Firm, stiff neck for easier handling
- Special designed neck to prevent the closures from falling in
- Both 6oz square bottom and 8oz round bottom bottles are available in bulk or tray packaging
- Tray packs are great for quick, effortless filling of bottles

Molded graduations

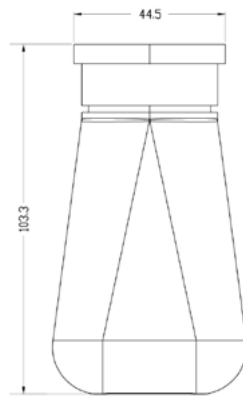

6oz

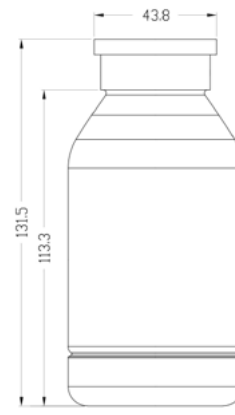

8oz

Dimensions = mm

Cat #	Product	Bottom	Material	Volume (ml)	Package	Unit	Total
51-17720	6oz Bottles	Square	PP	177	Bulk	200/Bag, 1 Bag/Case	200
51-17730	6oz Bottles	Square	PE	177	Bulk	200/Bag, 1 Bag/Case	200
51-22720	8oz Bottles	Round	PP	227	Bulk	100/Bag, 1 Bag/Case	100
51-22730	8oz Bottles	Round	PE	227	Bulk	100/Bag, 1 Bag/Case	100
51-17721	6oz Bottles Combo	Square	PP	177	Tray	25/Tray, 8 Trays/Case	200
51-17731	6oz Bottles Combo	Square	PE	177	Tray	25/Tray, 8 Trays/Case	200
51-22721	8oz Bottles Combo	Round	PP	227	Tray	25/Tray, 4 Trays/Case	100
51-22731	8oz Bottles Combo	Round	PE	227	Tray	25/Tray, 4 Trays/Case	100

Drosophila Plugs



>> Features

- Material: densest foam, densest sponge, and degreasing fiber are available
 - Densest foam:** the deformation effect is good and can maintain a tight fit to the vial wall after repeated use and multiple movements, high air permeability ensures the growth of drosophila
 - Densest sponge:** dense material, can completely block the entry of mites, moderate hardness, easy to operate, autoclavable, not easily deformed and damaged, and can be reused
 - Degreasing fiber:** excellent shaping effect makes the internal space compact and prevents mites from entering while still ensuring breathability, cost-effective, recommended for one-time use
- Causes minimal shedding and reduces evaporation
- Maintains tight fit after repeated use and removal

Flat surface accepts can be marked



narrow vials closures



wide vials closures



bottles closures

Cat #	Product	Material	Size (mm)	Unit
51-0505	Narrow Vials Closures	Densest Foam	30 x 45	100/Bag, 10 Bags/Case
51-0805	Wide Vials Closures	Densest Foam	35 x 45	100/Bag, 10 Bags/Case
51-17725	Bottles Closures	Densest Foam	45 x 45	50/Bag, 10 Bags/Case
51-0515	Narrow Vials Closures	Densest Sponge Autoclavable	25 x 25	100/Bag, 10 Bags/Case
51-0815	Wide Vials Closures	Densest Sponge Autoclavable	28 x 30	100/Bag, 10 Bags/Case
51-17735	Bottles Closures	Densest Sponge Autoclavable	40 x 30	100/Bag, 5 Bags/Case
51-0525	Narrow Vials Closures	Degreasing Fiber	24 x 30	100/Bag, 10 Bags/Case
51-0825	Wide Vials Closures	Degreasing Fiber	27 x 30	100/Bag, 10 Bags/Case



DK-31023



DK-31023C



DK-31023CS



DK-31023CK

>> Features

- Trinocular Microscope, eyepiece 10X/23mm(adjustable viewing)
- 1-year warranty
- External bottom light source and ring light, 3W-LED light source, and external double goose tube light source are available
- DK-31023C: with intelligent measuring camera
- DK-31023CS, DK-31023CK: with 10.5 inch Android smart all-in-one pad

Cat#	Product	Eyepieces (mm)	Light Source
DK-31023	Trinocular Microscope	10X/23	External double goose tube light source LED-06W
DK-31023C	Trinocular Microscope	10X/23	External bottom light source and ring light
DK-31023CS	Trinocular Microscope	10X/23	3W-LED light source and ring light
DK-31023CK	Trinocular Microscope	10X/23	Ring light

Sample Collection and Detection Products

Disposable Virus Collection Tube & Transportation, Preservation Medium



6ml or 12ml tubes with 2ml or 3ml medium.
 All available: Oral or nasal swabs, inactivated or non-inactivated medium.
 Package: Racked tubes or individually wrapped kits available.



Sample Collection Tubes



6ml or 10ml tubes without medium, self-standing bottom.
 Sterile.

Cat #	Volume	Sterile	Unit	Total
10-9052-RO	6ml	Yes	1000 Tubes/ Bag, 1000 Caps/ Bag	1000 Sets/ Case
10-9082-RO	10ml	Yes	500 Tubes/ Bag, 500 Caps/ Bag	500 Sets/ Case

Disposable Swabs



Oral or nasal swabs, individually wrapped; Sterile.
 Breaking point: 30mm or 80mm.

Disposable Saliva Sample Collectors



10ml tubes with inactivated or non-inactivated medium.
 Biohazard disposable bags available.
 Individually wrapped.



Instruments

In addition to consumable lab supplies, laboratory instruments are also important tools for life science research. High-quality lab instruments can greatly improve research efficiency and ensure precise and accurate results. Biologix now supplies small laboratory instruments for a wide variety of applications, including liquid handling, mixing, PCR, centrifuging, electrophoresis, and more.

Liquid Handling



dPette Digital Pipette

Features

- Comprehensive range of liquid handling protocols
- Three aspiration/dispensing speeds
- Motor-drive with built-in error control
- Efficient lithium-ion rechargeable battery
- Autoclavable lower barrel



MicroPette Plus Pipettes

Features

- Convenient one-handed operation
- Fully autoclavable
- Compatible with most standard pipette tips

Pipette Stand (01-2306)

- Holds up to six single- or multi-channel pipettes

*X stands for a different plug: 1- US Plug; 4- EURO Plug; 5-UK Plug

Cat #	Type	Channels	Volume Range (µL)	Tip Volume
01-241X	dPette Digital Pipette	1	0.5-10µL	0.01µL
01-242X	dPette Digital Pipette	1	5-50µL	0.1µL
01-243X	dPette Digital Pipette	1	30-300µL	1µL
01-244X	dPette Digital Pipette	1	100-1000µL	5µL
01-2101	MicroPette Plus Pipettes	1	0.5-10µL	0.1µL
01-2104	MicroPette Plus Pipettes	1	10-100µL	1µL
01-2102	MicroPette Plus Pipettes	1	20-200µL	1µL
01-2110	MicroPette Plus Pipettes	1	100-1000µL	5µL
01-2115	MicroPette Plus Pipettes	1	1000-5000µL	50µL
01-2112	MicroPette Plus Pipettes	1	0.1-2.5µL	0.05µL
01-2122	MicroPette Plus Pipettes	1	2-20µL	0.5µL
01-2155	MicroPette Plus Pipettes	1	5-50µL	0.5µL
01-2801	MicroPette Plus Pipettes	8	0.5-10µL	0.1µL
01-2805	MicroPette Plus Pipettes	8	5-50µL	0.5µL
01-2830	MicroPette Plus Pipettes	8	50-300µL	5µL
01-2210	MicroPette Plus Pipettes	12	0.5-10µL	0.1µL
01-2250	MicroPette Plus Pipettes	12	5-50µL	0.5µL
01-2230	MicroPette Plus Pipettes	12	30-300µL	5µL



Hipette Pipette

Features

- Ultra-light body. The weight is less than 75g
- Accurate pipetting. The new piston seal structure combined with metal screw to achieve more accurate pipetting and effectively reduce the pressing force
- Complete sterilization. UV sterilizable and resistant strong chemical corrosion

Cat#	Channel	Volume Range(μL)	Increment
01-2515	1	500-5000μL	5μL
01-2521	1	1000-10000μL	10μL



Levo ME Pipette Filler

Features

- Ergonomic shape and intuitive operation
- Pressure-sensitive buttons: increasing pressure increases aspiration/dispensing speed
- Autoclavable hydrophobic filter prevents over-aspiration
- LED light indicates aspiration/dispensing, charging, and low battery

*X stands for a different plug: 1- US Plug; 4- EURO Plug; 5-UK Plug

Cat #	Type	Aspiration Speeds	Dispensing Speeds	Battery Life	Compatible Pipette Types
01-221X	Levo ME	aspirates 25mL of water in < 7 seconds	gravity dispensing	8+ hours of intermittent use	glass or plastic pipettes (0.1-100mL), Pasteur pipettes



Levo Plus Pipette Filler

Features

- Six aspiration and dispensing speeds
- LCD display shows speed settings and remaining battery life
- Efficient lithium-ion battery can last for up to 8 hours of intermittent use
- Integral, autoclavable silicone adapter suits use with 0.1-100 mL pipettes

*X stands for a different plug: 1- US Plug; 4- EURO Plug; 5-UK Plug

Cat #	Type	Aspirate Speeds	Dispense Speeds	Battery Life	Compatible Pipette Types
01-220X	Levo Plus	25ml<5s(6 level)	Motor / Gravity	8+ hours of intermittent use	glass or plastic pipettes (0.1-100mL), Pasteur pipettes

Collection System



SAFEVAC Vacuum Aspiration System

Features

- Integrated pump with adjustable vacuum control
- Self-closing connectors for quick installation and dismantling, prevention of drips, and containment of aerosols
- Liquid level sensor prevents overflow
- Single-channel and multi-channel nozzles and other accessory options available

*X stands for a different plug: 1- US Plug; 4- EURO Plug; 5-UK Plug

Cat #	Vacuum range	Aspirating speed	Dimensions [W x D x H]	Weight	Input voltage	Bottle volume
01-270X	0 - 600 mbar	15 l/min	180 x 240 x 450mm	3 kg	100-240 VAC, 50/60 Hz	4L
01-272X	0 - 500 mbar	15 l/min	180 x 240 x 340mm	2.8 kg	100-240 VAC, 50/60 Hz	2L



Laboratory Fluid Collection System

Features

- Filmed inner wall
- Connection type: Can be connected with fluid instruments of various brands
- Funnel type: Equipped with the valve funnel
- High sealing performance
- Equipped with super efficient filter with connector
- Optional: Liquid level alarm



Cat #	Product	Description	Unit
05-2720	Connection type	One 20L security bucket with inner film , One inner cover, One outer cover, One set of liquid-phase connector, One set of efficient filter connector, One inorganic or organic filter	1 Set/Case
05-2721	Funnel type	One 20L security bucket with inner film , One inner cover, One outer cover, One funnel with a cover, One set of efficient filter connector, One inorganic or organic filter	1 Set/Case
05-2791	Super efficient filter	norganic chemical filter	1 Set/Case
05-2792	Super efficient filter	Organic chemical filter	1 Set/Case
05-2793	Liquid lever alarm	Tactile liquid lever alarm	1 Set/Case
05-2797	Liquid carrying cart(standard)	Adjustable size; one cart and one tray	1 Set/Case
05-2798	Liquid carrying cart(intelligent)	djustable size; one cart and one tray; equipped with intelligent module	1 Set/Case



Vortex Mixer

Features

- Orbital mixing movement
- Touch and continuous operation settings
- Cast aluminum base and specially designed vacuum suction feet keep the mixer stable
- Various adapters and accessories available for use with tubes of different sizes ($\Phi 6\text{mm}$, $\Phi 10\text{mm}$, $\Phi 12\text{mm}$, $\Phi 16\text{mm}$, $\Phi 20\text{mm}$ test tubes and vessels $<99\text{mm}$ in diameter)



Classic Rotators (axial) 01-130X



Classic Rotators (radial) 01-120X

Classic Rotators

Features

- End-over-end rotation
- Compact, space saving design
- Various adapters available for use with 1.5mL-50mL tubes

*X stands for a different plug: 1- US Plug; 4- EURO Plug; 5-UK Plug

Cat #	Type	Speed range [rpm]	Operation mode	Voltage [V]	Power [W]
01-110X	Vortex Mixer	0-3000	Touch operation/Continuous	110-120/220-230	60
01-120X	Classic Rotator	0-80	Continuous	100-240	20
01-130X	Classic Rotator	0-80	Continuous	100-240	20

Shakers

LED Digital Orbital and Linear Shaker



Features

- Electronic adjustment of speed and timer
- Double LEDs for independent display of time and speed
- Speed range of 40-200rpm
- Fixed board face, max. load capacity is 2kg with platform
- Continuous operation (endless)
- Electronic time switching clock: 1min-19h59min
- Wide range of platforms for use with a variety of vessels
- Work plate dimension (WxD): 268x268mm
- Timer display: LED
- Power: 20W
- Motor input power: 20W
- Motor output power: 16W
- Dimension (WxDxH): 294x348x123mm
- Weight: 3.1kg
- Permissible ambient temperature and humidity: 5-40 C ,80%RH

*X stands for a different plug: 1- US Plug; 4- EURO Plug; 5-UK Plug

Cat #	Orbital diameter	Speed range	Speed display	Motor type	Protection class	Voltage
01-621XA	20mm	40-200rpm	LED	DC motor	IP21	100-240V,50/60HZ

*Please call for more product models



Features

- Electronic adjustment of speed and timer
- Double LEDs for independent display of time and speed
- Speed range of 10-80 rpm
- Fixed board face, max. load capacity is 2kg with platform
- Continuous operation (endless)
- Electronic time switching clock: 1min-19h59min
- Wide range of platforms for use with a variety of vessels
- Work plate dimension (WxD): 268x268mm
- Power: 20W
- Motor input power: 20W
- Motor output power: 16W
- Dimension (WxDxH): 294x348x123mm
- Weight: 3.1kg
- Permissible ambient temperature and humidity: 5-40 C ,80%RH

*X stands for a different plug: 1- US Plug; 4- EURO Plug; 5-UK Plug

Cat #	Orbital diameter	Speed range	Speed display	Motor type	Protection class	Voltage
01-631XA	20mm	10-80rpm	LED	DC motor	IP20	100-240V,50/60HZ

*Please call for more product models



Gradient Thermocycler

Features

- Thermal gradient: program different temperatures across different areas of the heating block
- Consistent and uniform sealing across entire heating block
- Intuitive touch-screen user interface



Thermocycler

Features

- Consistent and uniform sealing across entire heating block
- Intuitive touch-screen user interface

*X stands for a different plug: 1- US Plug; 4- EURO Plug; 5-UK Plug

Cat #	Type	Heating Temperature Range [°C]	Temperature Display Accuracy [°C]	Max. Heating/Cooling Rate [°C/s]	Gradient Temperature Setting Range [°C]	Gradient Range [°C]
01-700X	Gradient Thermocycler	4-105	± 0.1	5° C/sec	30-99	1-42
01-710X	Thermocycler	4-105	± 0.1	5° C/sec	-	-

Centrifuges



Palm Micro Centrifuge

Features

- Quick acceleration and deceleration
- Rotors for microcentrifuge tubes, PCR tubes, and PCR 8-strip tubes included
- Quiet, low-noise design

*X stands for a different plug: 1- US Plug; 4- EURO Plug; 5-UK Plug

Cat #	Type	Max speed [rpm]	Max. RCF [xg]	Rotor Capacity
01-800X	Palm Micro Centrifuge	7000	2680	0.2ml/0.5ml/1.5ml/2ml x 8; 0.2ml x 32 PCR tubes or 0.2ml x 4 PCR 8-strips



High Speed Mini Centrifuges

Features

- Brushless DC motor quickly accelerates rotor to the set speed
- Rotors are designed for 1.5ml and 2ml microcentrifuge tubes; adapters for 0.2ml and 0.5ml tubes are also available

Specifications

01-821X (Mini-Plus) with 01-8291 plastic rotor kit*

- Low noise: 54dB; delivers fast acceleration and deceleration

*X stands for a different plug: 1- US Plug; 4- EURO Plug; 5-UK Plug

Cat #	Type	Speed Range [rpm]	Max. RCF [xg]	Rotor Capacity	Speed Accuracy [rpm]	Temperature Range [°C]
01-821X	Mini High Speed Centrifuge	500-15000; increment: 100	15100; increment: 100	0.2ml/0.5ml/ 1.5ml/2.0ml x 12	±20	N/A



High Speed Micro-Centrifuge

Features

- Bio-safe rotor prevents sample overflow and ensures samples do not leak during the centrifuging process
- High strength aluminum alloy rotor is autoclavable and highly durable
- Four different rotors are available, assembled with 1.5ml/2ml x 24

Cat #	Type	Speed Range [rpm]	Max. RCF [xg]	Rotor Capacity	Speed Accuracy [rpm]	Temperature Range [°C]
-------	------	-------------------	---------------	----------------	----------------------	------------------------

01-830X	High Speed Micro-Centrifuge	200-15000; 10	21380; increment: 10	5mlx18; 0.2ml/0.5ml/ 1.5ml/2ml x 24; 0.5ml x 36;PCR8 x 4	±20	N/A
---------	-----------------------------	------------------	-------------------------	--	-----	-----

*X stands for a different plug: 1- US Plug; 4- EURO Plug; 5-UK Plug

High-speed Refrigerated Micro Centrifuge

Features

- Centrifuge chamber door with automatic adsorption door lock design, can be closed with a single finger
- Precooling, the compressor will automatically start cooling as long as the set temperature is lower than the ambient temperature
- Sound indicator to prompt that the upper cover is closed to maintain the temperature inside the chamber, after centrifugation.
- Advanced R290 flurine free refrigerant ,low caron and environmental protection
- Maximum rotation speed can be achieved even at 4 °C .
- Up to 9 program storage capacity according to experimental needs
- Biosafety rotor, three-layer seal for biosafety.
- High-strength aluminum alloy, three layered biosafety to withstand numerous high temperature and high pressure sterilizations.
- Five rotors with 0.2ml, 0.5ml, 1.5ml, 2ml and 5ml centrifuge tubes/PCR tubes capacity



Centrifuge chamber door with automatic adsorption door lock design.



Powerful cooling capacity compressor.

large display

Intuitive operation control panel

*X stands for a different plug: 1- US Plug; 4- EURO Plug; 5-UK Plug

Cat #	Type	Max. Speed	Max. RCF [xg]	Rotor	Temperature setting
-------	------	------------	---------------	-------	---------------------

01-832X	High-speed Refrigerated Micro Centrifuge	15,000rpm (200-15,000rpm) in 100rpm increments.	21,380 step: 10	1.5/2mLx24,0.5mLx36, PCR8x4,5mLx12, 5mLx18	-20°C - 40°C
---------	--	---	--------------------	--	--------------

Centrifuges



Multi-Purpose Low Speed Centrifuge

Features

- Max. speed 4000rpm
- Rotor speed can be set in RPM/RCF, with 3 programs storage capacity for routine applications
- Max. capacity 50ml×4, Adapt to different sizes of blood collection tubes and centrifuge tubes suitable for swing out rotor and angle rotor. Automatic internal diagnosis and self-detection
- Maintenance-free brushless DC motor
- Noise: ≤62dB(A)
- Power: Single phase, 100V-240V, 50Hz/60Hz.



Multi-Purpose Low Speed Centrifuge

Features

- Speed range of 300-4000rpm
- 3 programs storage capacity for routine applications.
- Automatic internal diagnosis
Maintenance free brushless DC motor
- Noise: ≤60dB(A)
- Power: Single phase, 100V-240V, 50Hz/60Hz

*X stands for a different plug: 1- US Plug; 4- EURO Plug; 5-UK Plug

Cat #	Type	Speed range	Max. RCF [×g]	Rotor	Speed accuracy
01-860X	Multi-Purpose Low Speed Centrifuge	500-4000rpm increment: 100rpm	2500	Swing6×15ml Swing4×50ml Angle24×15ml, Angle12×10ml/8×15ml	±100rpm
01-870X	Multi-Purpose Low Speed Centrifuge	300-4000rpm increment: 100rpm	1900	Angel 8×15ml(Default), Angel 12× 10ml	±100rpm



Dry Bath Incubator

Features

- A broad temperature range, from room temperature to 120°C
- Continuous and timed operation settings
- Over-temperature protection
- Various interchangeable heating blocks are available (0.2ml x 54, 0.5ml x 40, 1.5/2ml x 40, 5/15ml x 28, 50ml x 8, 0.2ml+0.5ml+1.5/2ml, 96 or 384 well plate)

Cat #	Type	Functions	Temperature uniformity @37°C [°C]	Overheating protection	Max heating rate [°C/min]
-------	------	-----------	-----------------------------------	------------------------	---------------------------

01-910X	Dry Bath Incubator	Heating	± 0.5	140 °C	5.5
---------	--------------------	---------	-------	--------	-----

*X stands for a different plug: 1- US Plug; 4- EURO Plug; 5-UK Plug



Hot/Cold Dry Bath Incubator

Features

- Excellent temperature control system
- Can maintain hot or cold temperatures
- Supports creating and saving custom operation programs
- Various interchangeable heating blocks are available (24 x 0.5ml, 24 x 1.5ml, 24 x 2ml, 8 x 5ml, 8 x 15ml, 4 x 50ml, well plate, 0.2 x 96 PCR plate)

*X stands for a different plug: 1- US Plug; 4- EURO Plug; 5-UK Plug

Cat #	Type	Functions	Temperature range	Temperature control accuracy [°C, at 20–45°C]	Max heating rate [°C/min]
-------	------	-----------	-------------------	---	---------------------------

01-920X	Hot/Cold Dry Bath	Heating & cooling	Heating:room temp.~110°C Cooling:room temp.~ below room temp. 25°C	± 0.5	5.5
---------	-------------------	-------------------	---	-------	-----

Dry Bath Incubators



Shaker Incubator

Features

- Excellent temperature control system
- Can maintain hot or cold temperatures
- Orbital shaking movement function
- Supports creating and saving custom programs
- Various interchangeable heating blocks are available (24 x 0.5ml, 24 x 1.5ml, 24 x 2ml, 8 x 5ml, 8 x 15ml, 4 x 50ml, well plate, 0.2 x 96 PCR plate)

*X stands for a different plug: 1- US Plug; 4- EURO Plug; 5-UK Plug

Cat #	Type	Functions	Temperature range	Max heating rate [°C/min]	Max cooling rate [°C/min]	Shaking speed range [rpm]
01-930X	Shaker Incubator	Heating, cooling, & mixing	Heating:room temp.~100°C Cooling:room temp.~ below room temp. 15°C	5.5	5 (100°C - room temp.) 0.5 (below room temp.)	200-1500



One Block Unit



Dual Block Unit

Elite Series Dry Bath Incubators

Features

- PID temperature control maintains temperature accuracy
- Leak-proof molded aluminum alloy chamber with PTFE coating
- Multi-functional: can also be used as a water bath or bead bath
- Various interchangeable heating blocks are available (0.2ml tubes x 64 or PCR 8-strip tubes x 8, 0.5ml tubes x 20, 1.5ml or 2.0ml tubes x 20, 15ml x centrifuge tubes x12, 50ml x centrifuge tubes x4)
- Blocks are not included, need to buy separately.

Cat #	Type	Display	Temperature Control Range[°C]	Temperature Increment[°C]	Temperature Accuracy at 37[°C]	Operation Modes
03-4221	Elite Series One-Block Dry Bath Incubator	LCD Display	5 above ambient to 150	0.10	±20	Continuous or timed up to 99 hr:59 min
03-4222	Elite Series Dual Block Dry Bath Incubator	LCD Display	5 above ambient to 150	0.10	±20	Continuous or timed up to 99 hr:59 min

Dry bath

Features

- A wide range of temperature control up to 105°C /150°C .
- Overheating protection
- USB interface can be used to trace historical data
- Sound reminder function
- External temperature sensor
- Block equipped with a lid for heat preservation and prevent pollution
- Knob adjustment is easy to operate



*X stands for a different plug: 1- US Plug; 4- EURO Plug; 5-UK Plug

Cat #	Type	Temperature setting range[°C]	Temperature control accuracy [°C]	Power [w]	Operating temperature[°C]
01-900X	Dry bath	25~105	25-90:±0.3 90-105:±0.6	100	+10~40
01-9A0X	Dry bath	25~105	25-90:±0.3 90-105:±0.6	200	+10~40
01-950X	Dry bath	25~150	25-90:±0.3 90-150:±0.6	100	+10~40
01-960X	Dry bath	25~150	25-90:±0.3 90-150:±0.6	200	+10~40



Mini Dry bath

Features

- Light in weight
- LCD display of both temperature and time.
- Rapid calibration support
- Overheating protection
- Optional blocks with different capacities are available
- Safe and stable
- USB interface to save the data
- Mini 01-970x with hot lid provided to preserve the generated heat

*X stands for a different plug: 1- US Plug; 4- EURO Plug; 5-UK Plug

Cat #	Type	Temperature setting range[°C]	Temperature control accuracy[°C]
01-970X	Mini Dry bath	0~100	±0.5
01-980X	Mini Dry bath	0~100	±0.5
01-990X	Mini Dry bath	25~100	±0.5

Electrophoresis



Mini 300V Power Supply



300V Power Supply

Power Supplies

Features

- Stackable and programmable
- Multiple safety features: no-load detection, shrouded plugs and sockets, leakage detection, over-temperature protection, crossover protection, full floating, over-current/over-voltage detection

Cat #	Type	Output Voltage / Inc [V]	Output Current / Inc [mA]	Max Power [W]
03-1300	Mini 300V Power Supply	10-300/1	10-400/1	60
03-2310	300V Power Supply	5-300/1	1-700/1	150

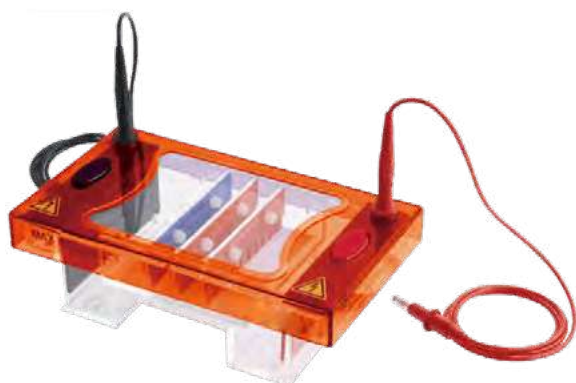

03-3100

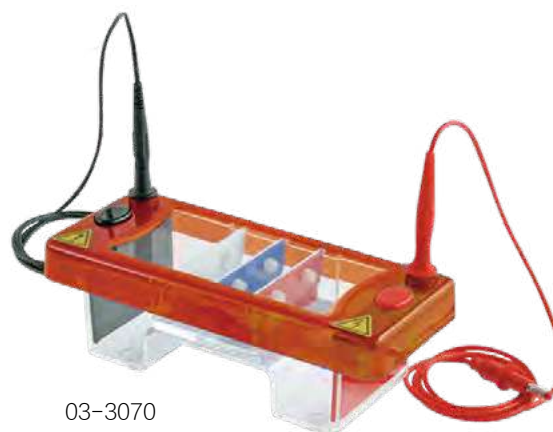

03-3070

Electrophoresis Tanks

Features

- Injection molded, leak-proof tank
- No tapes, clamps, or springs required
- Low buffer consumption
- Multiple tray sizes and combs available

Cat #	Tank Dimensions [W x L x H]	Gel Dimensions [mm]	Max. Sample Capacity [mm]	Rapid Casting Gel
03-3070	210 x 90 x 90mm	70 x 70, 70 x 100	32 for 70 x 70 64 for 70 x 100	Offer gel maker
03-3100	220 x 125 x 90mm	100 x 70, 100 x 100	50 for 100 x 70 100 for 100 x 100	Offer gel maker

BluView Transilluminator

Super bright blue LED lights can be used with a variety of safe dyes, and the lights are harmless and safe to view the experiment result. You can cut the gel with accuracy. With its compact size and light weight, the transilluminator occupies little of your lab bench and is easy to move from lab to lab.



BluView Transilluminator

Features

- Compact, and easy to carry
- Aluminum alloy casing design
- Low heat dispersion
- Energy saving product
- 470nm harmless blue light for direct human contact
- Thinner and more lightweight body
- Use accessories to document experiment results by a smart phone

Cat #	Blue Light Wavelength [nm]	Base Design	Construction Material	Power Adaptor	Filter Viewing Surface Dimensions [mm]
03-6210	470	Flat bed	Aluminum alloy	12VDC/5A, 60W Max.	153×153

Stirrers



Classic Magnetic Stirrer

Features

- Powerful rare-earth permanent magnet
- PET stirring plate provides excellent chemical resistance
- Stand included



FlatSpin Magnetic Stirrer

Features

- Ultra-flat, space-saving design
- Automatic rotation-reversing stirring for better mixing results
- Slip-resistant and stable



Magnetic Stirrer Hotplate

Features

- ABS casing is fire-retardant and resistant to weak acids and bases
- Ceramic-coated stainless steel hotplate is chemically resistant and scratch-proof
- Safety feature: HOT caution indicator is displayed at 50°C and above
- Digital temperature control with maximum temperature up to 280°C



EcoStir Square Plate Magnetic Stirrer

Features

- Compact design with small footprint, 12V voltage available for mobile labs
- Square work plate supports 1.5L stirring capacity
- Holder with clamp for pH electrode or another sensor
- Default PET top provides excellent chemical resistance
- Extra colorful stickers satisfy DIY design by yourself
- Maintenance free brushless DC moto

*X stands for a different plug: 1- US Plug; 4- EURO Plug; 5-UK Plug

Cat #	Type	Stirring plate size [mm]	Motor input rating [W]	Motor output rating [W]	Max. stirring quantity [H ₂ O]	Speed range [rpm]	Overheating Protection [°C]
01-330X	Ecostir (with round work plate)	Φ120	7.2	1.2	1.5L	300-2000	-
01-320X	FlatSpin	Φ90	5	3	0.8L	15-1500	-
01-310X	Hotplate	Φ135	5	3	3L	200-1500	320
01-330XA	(with square work plate)	120 x 115	7.2	1.2	1.5L	300-2000	-

Hotplate Magnetic Stirrer - 340° C

Features

- Brushless DC motor is maintenance free
- Digital temperature control with max. temperature at 340°C
- Stainless steel work plate with ceramic coating provides good chemical-resistant performance
- A wide variety of accessories are available



01-340X

*X stands for a different plug: 1- US Plug; 4- EURO Plug; 5-UK Plug

Cat#	Type	Stirring plate size [mm]	Motor input rating [W]	Motor output rating [W]	Max. stirring quantity [H ₂ O]	Speed range [rpm]	Overheating Protection [°C]
01-340X	LCD, with timer	Φ135mm(5 inch)	18W	10W	20L	100-1500rpm resolution±1rpm	420°C
01-341X	LCD Hotplate Stirrer	Φ135mm(5 inch)	18W	10W	20L	100-1500rpm resolution±1rpm	420°C
01-343X	Hotplate Stirrer	Φ135mm(5 inch)	18W	10W	20L	0-1500rpm	420°C
01-344X	Magnetic Stirrer	Φ135mm(5 inch)	18W	10W	20L	0-1500rpm	-

Hotplate Magnetic Stirrer - 550° C

Features

- Max. heating plate temperature 550°C
- Work plate material: Glass ceramic
- Chemical resistance



01-350X

*X stands for a different plug: 1- US Plug; 4- EURO Plug; 5-UK Plug

Cat#	Type	Stirring plate size [mm]	Max. stirring quantity [L, H ₂ O]	Speed range [rpm]	Motor Type	Work plate material
01-350X	LCD	184x184mm (7 inch)	20L	100-1500rpm resolution±1rpm	Brushless DC motor	Glass ceramic
01-351X	LED	184x184mm (7 inch)	10L	0-1500rpm	Shaded pole motor	Glass ceramic
01-352X	LED Hotplate	184x184mm (7 inch)	-	-	-	Glass ceramic
01-353X	Magnetic Stirrer	184x184mm (7 inch)	10L	0-1500rpm	Shaded pole motor	Glass ceramic

Multi-channel (Hotplate) Magnetic Stirrer

Features

- Max speed 1100rpm
- Maintenance-free brushless DC motor
- Multiple position
- Stainless steel work plate covered with silicone cushion, provides excellent performance of skid resistance



01-362X

*X stands for a different plug: 1- US Plug; 4- EURO Plug; 5-UK Plug

Cat#	Type	Stirring plate size [mm]	Motor input rating [W]	Motor output rating [W]	Max. stirring quantity [L, H ₂ O]	Speed range [rpm]	Overheating Protection [°C]
01-361X	Magnetic Stirrer	180×450mm	12W	4W	0.4Lx10	0-1100rpm	-
01-362X	Hotplate Magnetic Stirrer	180×450mm	12W	4W	0.4Lx10	0-1100rpm	140°C

Overhead Stirrer

Features

- Brushless DC motor for long life, maintenance free and explosion proof
- Self - locking drill chuck, tools free
- Spillage and overload protection safety circuits



01-373X

*X stands for a different plug: 1- US Plug; 4- EURO Plug; 5-UK Plug

Cat#	Type	Max. torque	Motor input rating	Motor output rating	Max. stirring quantity [H ₂ O]	Speed range	Viscosity max.
01-370X	LCD	60N•cm	120W	100W	40L	50~2200rpm	50000mPa•s
01-371X	LCD	40N•cm	60W	50W	20L	50~2200rpm	10000mPa•s
01-372X	LED	60N•cm	120W	100W	40L	50~2200rpm	50000mPa•s
01-373X	LED	40N•cm	60W	50W	20L	50~2200rpm	10000mPa•s

LCD Digital Rotary Evaporator



01-510X & 01-520X & 01-540X



Patented condenser



Patented double spring sealing ring



Large LCD display



Ejection mechanism

LCD Digital Rotary Evaporator

Features

- Digital display of both rotation speed and heating temperature allows for optimal control of all distillation processes
- Automatic motor lift releases the evaporating flask to a safe position in case of power failure
- 5L heating bath with wide temperature range from room temp. to 180°C, Water/oil heating mode can be changed only through a switch
- Boil-dry protection, automatically power off if heating without water/oil in the heating bath
- Speed range from 20 to 280rpm, and interval operation in clockwise and anticlockwise directions for drying process
- Patented condenser (cooling surface 1700cm²) with excellent cooling effect
- Ejection mechanism ensures easy removal of evaporating flask
- Patented double spring sealing ring made of PTFE provides an excellent sealing performance
- Remote function provides PC control and data transmission
- Optional glassware with explosion proof film available

*X stands for a different plug: 1- US Plug; 4- EURO Plug; 5-UK Plug

Cat#	Speed Range	Display	Heating Temperature Range	Control Accuracy	Time Setting Range
01-510X &01-520X&01-540X	20-280rpm	LCD	Room temp. to 180°C	Water: ±1°C Oil: ±3°C	1-999min

Electronic Analytical Balance

Electronic Analytical Balance

Features

- Black backlight 120*55 mm LCD screen
- Electromagnetic balance sensor
- External/ Internal calibration
- 4-level shockproof
- Counting function
- Supports PC connection. Wireless Bluetooth printing is optional
- The glass door draft shield has anti-static coating, which can shield external electrostatic interference.



*X stands for a different plug: 1- US Plug; 4- EURO Plug; 5-UK Plug

Cat#	Weighing Range	Calibration	Readability	Pan Size	Dimension/N.W.
01-BE2004EX	0-200g	External	0.1mg	Φ85mm	350*215*340mm/8KG
01-BE2204EX	0-220g	External	0.1mg	Φ85mm	350*215*340mm/8KG
01-BE2004NX	0-200g	Internal	0.1mg	Φ85mm	350*215*340mm/8KG
01-BE2204NX	0-220g	Internal	0.1mg	Φ85mm	350*215*340mm/8KG

Standard Accessories

Calibration Weight (for external calibration), Adapter, Manual, Dust cover

Touch Screen Electronic Analytical Balance

Features

- 4.3-inch color touch screen
- Powerful functions like weighing, parts counting, percent weighing, check weighing, animal weighing, density weighing, etc.
- Electromagnetic balance sensor
- External/ Internal calibration
- Supports Pc connection. Wireless Bluetooth printing is optional
- The sealed arc-shaped cover is made of acrylic material, beautiful appearance and easy to use

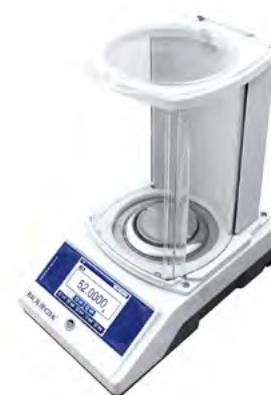

*X stands for a different plug: 1- US Plug; 4- EURO Plug; 5-UK Plug

Cat#	Weighing Range	Calibration	Readability	Pan Size	Dimension/N.W.
01-BD204EX	0-200g	External	0.1mg	Φ85mm	350*215*340mm/8KG
01-BD224EX	0-220g	External	0.1mg	Φ85mm	350*215*340mm/8KG
01-BD204NX	0-200g	Internal	0.1mg	Φ85mm	350*215*340mm/8KG
01-BD224NX	0-220g	Internal	0.1mg	Φ85mm	350*215*340mm/8KG
01-BD203EX	0-200g	External	1mg	Φ85mm	350*215*340mm/8KG
01-BD263EX	0-260g	External	1mg	Φ85mm	350*215*340mm/8KG
01-BD203NX	0-200g	Internal	1mg	Φ85mm	350*215*340mm/8KG
01-BD263NX	0-260g	Internal	1mg	Φ85mm	350*215*340mm/8KG

*Please call for more product models

Portal pH Meter

Features

- Large LCD screen with controllable white backlight
- Built-in microprocessor chip has intelligent functions such as auto calibration, ATC, data storage, function settings auto diagnosis, auto power off, and undervoltage prompt, etc.
- Auto recognition of 25 buffers with three kinds of options: Europe & USA, NIST and China Support 1, 2, 3 points calibration
- Adopt advanced conductivity measurement technology with conductivity electrode (K=1), it can meet measuring accuracy requirement for range of 0.5 μ S/cm ~ 200mS/cm
- Can switch among conductivity, TDS, salinity and resistivity. Multinomial calculation for TDS and salinity to ensure the conversion precision of the full scale.
- Auto recognition of 8 conductivity standard solution with 2 kinds of options: Europe & USA, and China



Cat #	PH			mV			Cond.				
	Measuring range	Resolution	Accuracy	Measuring range	Resolution	Accuracy	Measuring range	Resolution	Accuracy	Temp. compensation	Electrode constant
01-MP611							/	/	/	/	/
01-MP613	(-2.00~19.99) pH	0.1/0.01 pH	Meter: ± 0.01 pH; Overall: ± 0.02 pH	± 1999.9 mV	1 mV	$\pm 0.1\%$ FS	Conductivity: (0.00~19.99) μ S/cm (20.0~199.9) μ S/cm (200~1999)S/cm (2.00~19.99)mS/cm (20.0~199.9)mS/cm TDS:(0~100)g/L Salinity:(0~100)ppt Resistivity: (0~100)M Ω -cm	0.01/0.1/ 1/ μ S/cm; 0.01/0.1 mS/cm	$\pm 1.0\%$ FS, Overall: $\pm 1.5\%$ FS	(0~100) $^{\circ}$ C (Auto/manual)	0.1/1/10 cm ⁻¹

Touch Screen pH Meter

Features

- 7-inch colored capacitive touch screen with high resolution(1024*600) and high sensitivity
- Built-in microprocessor chip has Intelligent functions such as automatic calibration, ATC, data storage, clock display, USB output, function settings, wireless printing, and self-diagnosis information, etc.
- Auto recognition of 25 buffers with three kinds of options: Europe & USA NIST and China
- Auto recognition of 8 conductivity standard solution with 2 kinds of options: Europe & USA, and China
- It supports PC connection. Wireless bluetooth printing and real-time data transfer to mobile phone are optional
- Smart electrode status display to ensure accurate use
- Can store 1000 sets of test data, which can be saved and transferred



*X stands for a different plug: 1- US Plug; 4- EURO Plug; 5-UK Plug

Cat #	PH				mV			Cond.				
	Measuring range	Resolution	Accuracy	Auto calibration	Measuring range	Resolution	Accuracy	Measuring range	Resolution	Accuracy	Temp. compensation	Electrode constant
01-MP811X	(-2.00 ~ 20.00)pH	0.1/0.01 pH	± 0.02 pH			1 mV	$\pm 0.1\%$ FS	/	/	/	/	/
01-MP813X	(-1.999 ~ 19.999)pH	0.1/0.01/ 0.001 pH	Electrode: ± 0.002 pH, Meter: ± 0.01 pH	1, 2, 3 point	-1999.9mV ~ 0 ~ 1999.9mV	0.1 mV	$\pm 0.03\%$ FS	Conductivity: (0.00~20.00) μ S/cm, (20.0~200.0) μ S/cm (200~2000) μ S/cm, (2.00~20.00)mS/cm (20.0~200.0)mS/cm, (200~2000)mS/cm(K=10) TDS:(0~100)g/L Salinity:(0~100)ppt Resistivity:(0~100)M Ω -cm	0.01/0.1/1 μ S/cm; 0.01/0.1 mS/cm	Electrode: $\pm 0.5\%$ FS, Meter: 0.8% FS	(0~100) $^{\circ}$ C, auto	0.1/0.5/1/5/ 10/50/100 cm ⁻¹

Application Guidelines

Maximum centrifugal acceleration force can be influenced by following criteria:

- Use of organic solutions, temperature below 0°C, centrifuging without centrifuge adapter, etc. Conduct a trial run to determine proper conditions before any critical use begins.
- The RCF (relative centrifugal force) or G ratings for our disposable centrifuge tubes have been established at room temperature using tubes filled to nominal capacity with water and centrifuging for 30 minutes. recommended carriers, adapters, and cushions that fully support the tubes. If an angle head rotor is used or proper support is not provided, G values will be lower.
- Do not confuse speed or revolutions per minute (RPM) with relative centrifugal force (RCF). Instructions for centrifuging a sample at a given RPM and time are incomplete unless the rotor or radius is specified. Protocols should always state the time and RCF value for centrifuging a sample.

Autoclaving guideline for Plastics

To ensure successful steam sterilization of your plastic labware please adhere to the following guidelines:

PLEASE NOTE THAT NOT ALL PRODUCTS ARE AUTOCLAVABLE. Autoclave plastic consumables at 121°C and 15psi/1 atm for 15 minutes. Do not use a dry cycle, as this may cause deformation or weakening of the plastic. Allow temperature within the autoclave to return to 80°C or below before removing products.

Our Commitment to Quality

At Biologix, we look at quality from every angle in terms of functionality, safety, purity, formulation, consistency, manufacturing, customer service, technical support, and much more, all in order to consistently ensure customer satisfaction.

According to the detailed QA/QC procedures for our manufacturing facility, each and every product is traceable by lot, regardless of packaging format. Products must go through a five-step human inspection before being released for packaging.

Our facility is equipped with the latest instruments and technology from the most trusted manufacturers, ensuring that Biologix applies the most stringent standards to certify that products are free from RNase, DNase, endotoxin (pyrogens), etc.

In addition to being ISO 9001: 2015, ISO 13485, CE, and FDA compliant, we also make available to our customers lot-specific certificates such as Sterilization Certificates, Nuclease Free Certificates, Certificates of Origin, etc. Please contact Biologix for Certificates of Compliance.

Note: Product parameters within this catalogue are for reference only.

Chemical Resistance Form

For Biologix Plastic Laboratory Supplies

	PS	PP	HDPE	LDPE	PVC	CA	PC	CN	NY	MCE	PTFE	PET
Acids												
Hydrochloric acid (25%)	G	G	G	G	G	N	R	R	N	O	R	R
Hydrochloric acid (concentrated)	F	G	G	G	F	N	R	N	N	N	R	O
Nitric acid (concentrated)	P	P	N	N	P	N	R	N	N	N	O	N
Nitric acid (25%)	P	G	F	F	F	N	R	L	N	O	R	R
Alcohols												
Butanol	G	G	G	G	G	R	R	R	R	R	R	R
Ethanol	G	G	G	G	G	R	R	N	R	O	R	R
Methanol	G	G	G	G	G	R	R	N	R	O	R	R
Amines												
Aniline	G	G	G	G	P	N	N	R	R	N	R	O
Dimethylformamide	P	G	G	G	F	N	N	N	R	N	R	N
Bases												
Ammonium hydroxide (25%)	F	G	G	G	G	R	N	R	R	O	N	O
Ammonium hydroxide (1N)	F	G	G	G	G	N	N	R	R	O	N	N
Sodium hydroxide	G	G	G	G	G	N	N	N	R	N	R	N
Hydrocarbons												
Hexane	P	G	G	G	F	R	R	R	R	R	R	R
Toluene	P	G	N	N	P	R	O	R	R	R	R	N
Xylene	P	F	P	N	P	R	R	R	R	R	R	N
Dioxane	P	G	G	F	P	N	N	N	R	N	R	R
Dimethylsulfoxide (DMSO)	P	G	G	G	P	N	N	N	R	N	R	O*
Halogenated Hydrocarbons												
Chloroform	P	G	P	N	P	N	N	R	R	N	R	R
Methylene chloride	P	F	P	N	P	N	N	R	R	N	R	N
Ketones												
Acetone	P	G	G	G	P	N	O	N	R	N	R	R
Methyl ethyl diketone	P	G	G	G	P	N	O	N	R	O	R	R

* Can be used with aqueous solutions containing up to 20% DMSO.

The above chemical resistance chart is meant to be used as a guide only.

LEGEND

R = Recommended

L = Limited Resistance

N = Not Recommended

O = Testing Advised

F = Fair

G = Good

P = Poor

PS = Polystyrene

PP = Polypropylene

PVC = Polyvinyl Chloride

CA = Cellulose Acetate

PC = Polycarbonate

PTFE = Polytetrafluorethylene (Teflon)

CN = Cellulose Nitrate

NY = Nylon

MCE = Mixed Cellulose Esters

PET = Polyethylene Terephthalate

Biologix Group Limited

Phone: +86-531-67802668

Inquiry@BiologixGroup.com

www.BiologixGroup.com

www.CryoKING.com

Biologix USA, Inc.

Customercare@BiologixUSA.com

Phone: (805)586-6718 ext 101

www.BiologixUSA.com

Biologix Europe GmbH

Ludwigstrasse 44, 85399

Hallbergmoos, Germany

www.BiologixEurope.com

Biologix Corporation

No.2766 Ying Xiu Road

High-Tech Industrial Development Zone

Jinan, Shandong 250101

P.R. China

www.Biologix.cn



BIOL
KING